

JapKo[®]

CATALOGO - CATALOGUE
CROCIERE TRIPODE
E CARDANICHE

SPIDERS - TRIPODS
AND CARDAN CRUISES
2025



www.japko.it

JAPANPARTS S.R.L.

Via della Meccanica, 1/A - 37139 - Verona (IT)

tel. +39 045 8517711 - fax + 39 045 8510714

info@japanparts.it

INDICE - INDEX

MARCA AUTO (CAR BRAND) :	Pagina (Page)
ALFA ROMEO	37
ASIA MOTOR	38
BMW	39
CHEVROLET	40
DACIA	41
DAIHATSU	42
DODGE	43
FIAT	44
FORD	45
GREAT WALL	46
HONDA	47
HUMMER	48
HYUNDAI	49
ISUZU	50
IVECO	51
JEEP	52 - 53
KIA	54
LANCIA	55
LAND ROVER	56
MAHINDRA	57
MAZDA	58 - 59
MERCEDES	60
MITSUBISHI	61 - 63
NISSAN	64 - 65
OPEL	66
PIAGGIO	67
RAM	68
SAAB	69
SSANGYONG	70
SUZUKI	71
TATA	72
TOYOTA	73 - 74
VOLKSWAGEN	75
IMMAGINI (IMAGES)	76 - 82

CROCIERE TRIPODE
SPIDERS - TRIPODS

JapKo[®]

APPLICAZIONE (APPLICATION)	ANNO (YEAR)	CODICE (CODE)	O.E. (OR. NUM.)	Ø RULLO (ROLLER)	H. RULLO (ROLLER)	H. TOT. (TOT.)	N. DENTI (TEETH)
145 - 146 (930) (1,4 i.e. 16v. T.S.)	11/96 > 01/01	660220	46448513 60813073	32	10,5	23,6	22
147 (937) (1,9 JTD)	04/01 > 03/10	660219	46308125 46308126 60802020	43,2	14,5	22	26
156 (932) (1,9 JTD)	05/01 > 05/06	660219	46308125 46308126 60802020	43,2	14,5	22	26
159 (939) (1,8 MPI - TBI)	03/07 > 11/11	660223	46308281	41,5	14	20,6	24
159 (939) (1,9 JTD)	09/05 > 11/11	660219	46308125 46308126 60802020	43,2	14,5	22	26
159 (939) (2,0 JTD - 2,4 JTD)	09/05 > 11/11	660206	46308241	46,6	16,2	23	27
166 (936) (2,4 JTD)	10/03 > 06/07	660219	46308125 46308126 60802020	43,2	14,5	22	26
BRERA (2,2 JTS - 3,2 JTS)	01/06 >	660219	46308125 46308126 60802020	43,2	14,5	22	26
BRERA (2,4 JTDM)	01/06 >	660206	46308241	46,6	16,2	23	27
GIULIETTA (940) (1,4 TB - 1,6 JTDM)	04/10 >	660219	46308125 46308126 60802020	43,2	14,5	22	26
GIULIETTA (940) (1,8 TBI - 2,0 JTDM)	04/10 >	660206	46308241	46,6	16,2	23	27
GT (937) (1,9 JTD)	11/03 >	660219	46308125 46308126 60802020	43,2	14,5	22	26
MITO (955) (0,9 TURBO TWIN AIR)	07/11 >	660209	46307552 46307825	32	10,5	24	21
MITO (955) (1,4 16v.)	08/08 >	660209	46307552 46307825	32	10,5	24	21
MITO (955) (1,4 16v. - 1,4 TWIN AIR 16v.)	08/08 >	660209	46307552 46307825	32	10,5	24	21
MITO (955) (1,4 TURBO 16v.)	07/08 > 02/11	660205	46308470	39,2	11,6	25	24

N.B.: I CODICI O.E. ED IL LORO TESTO SONO RIPORTATI SOLO A TITOLO INDICATIVO
THE O.E. CODES AND THEIR TEXT ARE REPORTED ONLY FOR INDICATIVE PURPOSE

APPLICAZIONE (APPLICATION)	ANNO (YEAR)	CODICE (CODE)	O.E. (OR. NUM.)	Ø RULLO (ROLLER)	H. RULLO (ROLLER)	H. TOT. (TOT.)	N. DENTI (TEETH)
500 (0,9 TURBO TWIN AIR)	09/10 >	660209	46307552 46307825	32	10,5	24	21
500 (1,2)	10/07 >	660208	46308007	29,2	9,5	23,7	20
500 (1,4 16v.)	07/07 >	660209	46307552 46307825	32	10,5	24	21
500 (1,4 ABARTH 16v.)	08/08 >	660216	46307676	35,5	11,7	27	24
500 (1,3 MJTD 16v.)	07/07 > 08/12	660209	46307552 46307825	32	10,5	24	21
500 (1,3 MJTD - 95 cv.)	07/07 >	660214	46308327	33,9	11,7	26,5	23
500 L (0,9 TURBO TWIN AIR)	09/12 >	660209	46307552 46307825	32	10,5	24	21
500 L (1,4 16v.)	09/12 >	660209	46307552 46307825	32	10,5	24	21
500 L (1,4 T-JET)	11/13 >	660205	46308470	39,2	11,6	25	24
500 L (1,3 MJTD 16v.)	09/12 >	660216	46307676	35,5	11,7	27	24
500 L (1,6 MJTD 16v.)	11/13 >	660205	46308470	39,2	11,6	25	24
BRAVO/A (1,2 16v.)	12/98 > 12/02	660210	7702194 7702195 5949990	32	10,5	23,7	20
BRAVO/A (1,4 12v. - 1,6 16v.)	10/95 > 10/01	660220	46448513 60813073	32	10,5	23,6	22
BRAVO/A (1,4 16v. - 1,8 GT)	10/95 > 10/01	660210	7702194 7702195 5949990	32	10,5	23,7	20
BRAVO/A (1,9 D)	10/95 > 10/01	660210	7702194 7702195 5949990	32	10,5	23,7	20
BRAVO II (1,4 16v.)	01/10 >	660209	46307552 46307825	32	10,5	24	21

N.B.: I CODICI O.E. ED IL LORO TESTO SONO RIPORTATI SOLO A TITOLO INDICATIVO
THE O.E. CODES AND THEIR TEXT ARE REPORTED ONLY FOR INDICATIVE PURPOSE

APPLICAZIONE (APPLICATION)	ANNO (YEAR)	CODICE (CODE)	O.E. (OR. NUM.)	Ø RULLO (ROLLER)	H. RULLO (ROLLER)	H. TOT. (TOT.)	N. DENTI (TEETH)
BRAVO II (1,4 T-JET)	07/07 > 12/09	660219	46308125 46308126 60802020	43,2	14,5	22	26
BRAVO II (1,4 T-JET)	01/10 >	660205	46308470	39,2	11,6	25	24
BRAVO II (1,6 MJTD)	03/08 >	660219	46308125 46308126 60802020	43,2	14,5	22	26
BRAVO II (1,6 MJTD)	03/08 >	660205	46308470	39,2	11,6	25	24
BRAVO II (1,9 MJTD)	04/07 > 12/09	660219	46308125 46308126 60802020	43,2	14,5	22	26
BRAVO II (1,9 MJTD)	01/10 >	660205	46308470	39,2	11,6	25	24
BRAVO II (2,0 JTDM)	09/08 >	660206	46308241	46,6	16,2	23	27
CINQUECENTO (0,9 - 0,9 i.e.)	07/91 > 07/99	660202	7540062 7566182 4671609	29,5	9,5	24	19
CINQUECENTO (1,1 SPORTING)	10/94 > 01/98	660202	7540062 7566182 4671609	29,5	9,5	24	19
CROMA (194) (1,9 MJTD - 2,4 MJTD)	06/05 >	660219	46308125 46308126 60802020	43,2	14,5	22	26
DOBLO' I (1,2 - 1,6 16v.)	03/01 >	660209	46307552 46307825	32	10,5	24	21
DOBLO' I (1,3 JTD 16v.)	02/04 >	660216	46307676	35,5	11,7	27	24
DOBLO' I (1,9 D)	03/01 >	660209	46307552 46307825	32	10,5	24	21
DOBLO' I (1,9 JTD 16v.)	09/01 >	660216	46307676	35,5	11,7	27	24
DOBLO' II (1,4)	11/05 > 12/09	660209	46307552 46307825	32	10,5	24	21
DOBLO' II (1,3 JTD 16v.)	11/05 >	660216	46307676	35,5	11,7	27	24

N.B.: I CODICI O.E. ED IL LORO TESTO SONO RIPORTATI SOLO A TITOLO INDICATIVO
THE O.E. CODES AND THEIR TEXT ARE REPORTED ONLY FOR INDICATIVE PURPOSE

APPLICAZIONE (APPLICATION)	ANNO (YEAR)	CODICE (CODE)	O.E. (OR. NUM.)	Ø RULLO (ROLLER)	H. RULLO (ROLLER)	H. TOT. (TOT.)	N. DENTI (TEETH)
DOBLO' II (1,9 JTD 16v.)	11/05 >	660216	46307676	35,5	11,7	27	24
DOBLO' III (1,4 16v.)	01/10 >	660209	46307552 46307825	32	10,5	24	21
DOBLO' III (1,3 MJTD)	02/10 >	660205	46308470	39,2	11,6	25	24
DOBLO' III (1,6 MJTD)	02/10 >	660219	46308125 46308126 60802020	43,2	14,5	22	26
DOBLO' III (1,6 MJTD 16v.)	02/10 >	660223	46308281	41,5	14	20,6	24
DOBLO' III (2,0 MJTD)	02/10 >	660206	46308241	46,6	16,2	23	27
DUCATO (T.T.)	82 > 94	660225		50,2	16	30	27
DUCATO (T.T.)	94 > 06	660217	1491235080	38,8	13,6	28	39
DUCATO (T.T.)	07/06 >	660218	46308387	43,65	13,3	27,3	27
DUCATO (T.T.)	07/06 >	660222	46308312	42	14,7	32,7	29
DUNA (T.T.)	01/87 > 12/91	660210	7702194 7702195 5949990	32	10,5	23,7	20
FIORINO (146) (T.T.)	04/94 > 05/01	660210	7702194 7702195 5949990	32	10,5	23,7	20
FIORINO (225) (1,4)	11/07 >	660207	46308047	31,9	10,9	25,3	22
FIORINO (225) (1,4)	11/07 >	660209	46307552 46307825	32	10,5	24	21
FIORINO (225) (1,3 MJTD)	11/07 >	660216	46307676	35,5	11,7	27	24
FIORINO (225) (1,3 MJTD - 75 cv.)	11/07 >	660214	46308327	33,9	11,7	26,5	23

N.B.: I CODICI O.E. ED IL LORO TESTO SONO RIPORTATI SOLO A TITOLO INDICATIVO
THE O.E. CODES AND THEIR TEXT ARE REPORTED ONLY FOR INDICATIVE PURPOSE

APPLICAZIONE (APPLICATION)	ANNO (YEAR)	CODICE (CODE)	O.E. (OR. NUM.)	Ø RULLO (ROLLER)	H. RULLO (ROLLER)	H. TOT. (TOT.)	N. DENTI (TEETH)
GRANDE PUNTO (199) (1,2)	10/05 >	660224	51733783	32	10,5	24	27
GRANDE PUNTO (199) (1,2 - 1,4)	10/05 >	660209	46307552 46307825	32	10,5	24	21
GRANDE PUNTO (199) (1,4 T-JET)	09/07 >	660205	46308470	39,2	11,6	25	24
GRANDE PUNTO (199) (1,4 ABARTH 16v.)	12/07 >	660203	71745019	37,5	9,8	26,6	33
GRANDE PUNTO (199) (1,3 MJTD 75/90 cv.)	10/05 >	660214	46308327	33,9	11,7	26,5	23
GRANDE PUNTO (199) (1,3 MJTD)	10/05 >	660216	46307676	35,5	11,7	27	24
GRANDE PUNTO (199) (1,6 MJTD 16v.)	01/08 > 12/08	660205	46308470	39,2	11,6	25	24
GRANDE PUNTO (199) (1,6 MJTD 16v.)	12/08 >	660203	71745019	37,5	9,8	26,6	33
GRANDE PUNTO (199) (1,9 JTD)	10/05 >	660203	71745019	37,5	9,8	26,6	33
IDEA (1,2 - 1,4 - 1,4 16v.)	03/10 >	660209	46307552 46307825	32	10,5	24	21
IDEA (1,3 MJTD - 69 cv.)	10/03 >	660214	46308327	33,9	11,7	26,5	23
IDEA (1,3 MJTD)	10/05 >	660216	46307676	35,5	11,7	27	24
IDEA (1,6 MJTD)	05/08 >	660219	46308125 46308126 60802020	43,2	14,5	22	26
IDEA (1,9 MJTD)	10/03 >	660216	46307676	35,5	11,7	27	24
LINEA (1,4 8v.)	06/07 >	660209	46307552 46307825	32	10,5	24	21
LINEA (1,4 16v.)	06/07 >	660205	46308470	39,2	11,6	25	24

N.B.: I CODICI O.E. ED IL LORO TESTO SONO RIPORTATI SOLO A TITOLO INDICATIVO
THE O.E. CODES AND THEIR TEXT ARE REPORTED ONLY FOR INDICATIVE PURPOSE

APPLICAZIONE (APPLICATION)	ANNO (YEAR)	CODICE (CODE)	O.E. (OR. NUM.)	Ø RULLO (ROLLER)	H. RULLO (ROLLER)	H. TOT. (TOT.)	N. DENTI (TEETH)
LINEA (1,3 JTD - 1,6 JTD)	06/07 >	660205	46308470	39,2	11,6	25	24
LINEA (1,3 JTD - CAMBIO SELESPEED)	06/07 >	660216	46307676	35,5	11,7	27	24
LINEA (1,6 MJTD)	06/09 >	660219	46308125 46308126 60802020	43,2	14,5	22	26
MAREA (1,2 16v. - 1,4 16v. - 1,6 16v.)	09/96 > 05/02	660220	46448513 60813073	32	10,5	23,6	22
MAREA (1,4 12v.)	09/96 > 05/02	660210	7702194 7702195 5949990	32	10,5	23,7	20
MAREA (1,9 TD - 1,9 JTD)	09/96 > 08/02	660221	46307152	39,9	13	20	30
MULTIPLA (1,6 16v.)	04/99 > 06/10	660220	46448513 60813073	32	10,5	23,6	22
PALIO (1,2 - 1,4 - 1,6 16v.)	06/98 >	660220	46448513 60813073	32	10,5	23,6	22
PALIO WEEKEND (1,2 - 1,6 16v.)	04/96 >	660210	7702194 7702195 5949990	32	10,5	23,7	20
PALIO WEEKEND (1,2 - 1,6 16v.)	04/96 >	660220	46448513 60813073	32	10,5	23,6	22
PALIO WEEKEND (1,7 TD - 1,9 D)	04/96 >	660210	7702194 7702195 5949990	32	10,5	23,7	20
PALIO WEEKEND (1,9 D)	03/01 >	660220	46448513 60813073	32	10,5	23,6	22
PALIO WEEKEND (1,9 JTD)	09/01 > 09/02	660221	46307152	39,9	13	20	30
PALIO II - PALIO WEEKEND II (1,2 - 1,6)	02 >	660224	51733783	32	10,5	24	27
PALIO II - PALIO WEEKEND II (1,3 JTD)	07 >	660216	46307676	35,5	11,7	27	24
PANDA (141) (750 - 1000 - 1,3 D)	01/85 > 86	660215	5946475	19,2	9,5	23,7	20

N.B.: I CODICI O.E. ED IL LORO TESTO SONO RIPORTATI SOLO A TITOLO INDICATIVO
THE O.E. CODES AND THEIR TEXT ARE REPORTED ONLY FOR INDICATIVE PURPOSE

APPLICAZIONE (APPLICATION)	ANNO (YEAR)	CODICE (CODE)	O.E. (OR. NUM.)	Ø RULLO (ROLLER)	H. RULLO (ROLLER)	H. TOT. (TOT.)	N. DENTI (TEETH)
PANDA (141) (750 - 900)	86 >	660202	7540062 7566182 4671609	29,5	9,5	24	19
PANDA (141) (1,0 4X4 - 1,1 4X4)	01/85 > 07/04	660202	7540062 7566182 4671609	29,5	9,5	24	19
PANDA (141) (1,3 D)	04/86 > 12/92	660202	7540062 7566182 4671609	29,5	9,5	24	19
PANDA (169) (1,1 - 1,2)	09/03 >	660208	46308007	29,2	9,5	23,7	20
PANDA (169) (1,2)	09/03 >	660209	46307552 46307825	32	10,5	24	21
PANDA (169) (1,2 4X4)	09/04 >	660204	46308103	29,9	10,2	22,9	20
PANDA (169) (1,2 - 1,2 4X4)	10/04 >	660207	46308047	31,9	10,9	25,3	22
PANDA (169) (1,4)	04/09 >	660209	46307552 46307825	32	10,5	24	21
PANDA (169) (1,3 JTD)	09/03 >	660209	46307552 46307825	32	10,5	24	21
PANDA (169) (1,3 MJTD 4X4)	09/04 >	660204	46308103	29,9	10,2	22,9	20
PANDA (169) (1,3 MJTD 4X4)	10/04 >	660207	46308047	31,9	10,9	25,3	22
PANDA (312) (0,9 TURBO)	01/12 >	660209	46307552 46307825	32	10,5	24	21
PANDA (312) (1,1 - 1,2 - 1,2 BI-POWER)	01/12 >	660208	46308007	29,2	9,5	23,7	20
PANDA (312) (1,3 MJTD 16v. 75 cv.)	01/12 >	660214	46308327	33,9	11,7	26,5	23
PANDA (312) (1,3 MJTD 16v.)	01/12 >	660216	46307676	35,5	11,7	27	24
PUNTO (176) (1,1 / 55 - 1,2 / 60)	09/93 > 09/99	660202	7540062 7566182 4671609	29,5	9,5	24	19

N.B.: I CODICI O.E. ED IL LORO TESTO SONO RIPORTATI SOLO A TITOLO INDICATIVO
THE O.E. CODES AND THEIR TEXT ARE REPORTED ONLY FOR INDICATIVE PURPOSE

APPLICAZIONE (APPLICATION)	ANNO (YEAR)	CODICE (CODE)	O.E. (OR. NUM.)	Ø RULLO (ROLLER)	H. RULLO (ROLLER)	H. TOT. (TOT.)	N. DENTI (TEETH)
PUNTO (176) (1,2 - 1,2 16v. - 1,6)	04/94 > 07/99	660210	7702194 7702195 5949990	32	10,5	23,7	20
PUNTO (176) (1,7 D - TD)	04/94 > 07/99	660210	7702194 7702195 5949990	32	10,5	23,7	20
PUNTO (176) (1,7 TD)	09/96 >	660220	46448513 60813073	32	10,5	23,6	22
PUNTO (188) (1,2 - 1,2 16v.)	08/99 >	660209	46307552 46307825	32	10,5	24	21
PUNTO (188) (1,2)	01/03 >	660224	51733783	32	10,5	24	27
PUNTO (188) (1,8 HGT)	08/99 >	660221	46307152	39,9	13	20	30
PUNTO (188) (1,3 JTD)	06/03 >	660221	46307152	39,9	13	20	30
PUNTO (188) (1,9 D)	08/99 >	660209	46307552 46307825	32	10,5	24	21
PUNTO (188) (1,9 JTD)	08/99 >	660221	46307152	39,9	13	20	30
PUNTO EVO (199) (1,2 - 1,4 - 1,4 16v.)	11/09 > 10/11	660209	46307552 46307825	32	10,5	24	21
PUNTO EVO (199) (1,4 T-JET)	01/09 > 10/11	660205	46308470	39,2	11,6	25	24
PUNTO EVO (199) (1,4 ABARTH 16v.)	07/08 >	660219	46308125 46308126 60802020	43,2	14,5	22	26
PUNTO EVO (199) (1,3 MJTD)	01/09 > 10/11	660205	46308470	39,2	11,6	25	24
PUNTO EVO (199) (1,3 MJTD 75/90 cv.)	11/09 > 10/11	660214	46308327	33,9	11,7	26,5	23
PUNTO EVO (199) (1,3 MJTD 16v.)	11/09 >	660216	46307676	35,5	11,7	27	24
PUNTO EVO (199) (1,6 MJTD 16v.)	11/09 > 10/11	660203	71745019	37,5	9,8	26,6	33

N.B.: I CODICI O.E. ED IL LORO TESTO SONO RIPORTATI SOLO A TITOLO INDICATIVO
THE O.E. CODES AND THEIR TEXT ARE REPORTED ONLY FOR INDICATIVE PURPOSE

APPLICAZIONE (APPLICATION)	ANNO (YEAR)	CODICE (CODE)	O.E. (OR. NUM.)	Ø RULLO (ROLLER)	H. RULLO (ROLLER)	H. TOT. (TOT.)	N. DENTI (TEETH)
PUNTO '12 (199) (0,9 TB - 1,2 - 1,4)	10/11 >	660209	46307552 46307825	32	10,5	24	21
PUNTO '12 (199) (1,4 TURBO 16v.)	10/11 >	660205	46308470	39,2	11,6	25	24
PUNTO '12 (199) (1,3 MJTD 75/85/95 cv.)	10/11 >	660214	46308327	33,9	11,7	26,5	23
PUNTO '12 (199) (1,3 MJTD)	10/11 >	660205	46308470	39,2	11,6	25	24
QUBO (1,4)	09/08 >	660207	46308047	31,9	10,9	25,3	22
QUBO (1,4)	09/09 >	660209	46307552 46307825	32	10,5	24	21
QUBO (1,3 MJTD)	09/08 >	660216	46307676	35,5	11,7	27	24
QUBO (1,3 MJTD 16v. - 75cv.)	09/08 >	660214	46308327	33,9	11,7	26,5	23
SCUDO (220 - 222) (T.T.)	01/96 >	660600	1497191088 9619947588	33	12,7	26	34
ULYSSE (220 - 179) (T.T.)	06/94 > 06/11	660600	1497191088 9619947588	33	12,7	26	34

N.B.: I CODICI O.E. ED IL LORO TESTO SONO RIPORTATI SOLO A TITOLO INDICATIVO
THE O.E. CODES AND THEIR TEXT ARE REPORTED ONLY FOR INDICATIVE PURPOSE

APPLICAZIONE (APPLICATION)	ANNO (YEAR)	CODICE (CODE)	O.E. (OR. NUM.)	Ø RULLO (ROLLER)	H. RULLO (ROLLER)	H. TOT. (TOT.)	N. DENTI (TEETH)
C/MAX (T.T.)	02/07 > 09/10	660302	1061888 1476895 1685795	33,9	11,8	26,6	23
FIESTA (MOT. 1,4 TDCI)	01 > 08	660301	1202534 2S613W007A A	30	10,2	22	20
FOCUS I - II (T.T.)	10/98 > 09/11	660302	1061888 1476895 1685795	33,9	11,8	26,6	23
FUSION (MOT. 1,4 TDCI)	01 > 12	660301	1202534 2S613W007AA	30	10,2	22	20
GALAXY (1,9 TDI)	02/06 > 05/06	660300	1308629	43,2	14,5	22	34
MONDEO III (T.T.)	10/00 > 03/07	660303	1447556	38	16,4	22,4	33
TOURNEO CONNECT (T.T.)	06/02 > 12/13	660223	4490557	41,5	14	20,6	24

N.B.: I CODICI O.E. ED IL LORO TESTO SONO RIPORTATI SOLO A TITOLO INDICATIVO
THE O.E. CODES AND THEIR TEXT ARE REPORTED ONLY FOR INDICATIVE PURPOSE

APPLICAZIONE (APPLICATION)	ANNO (YEAR)	CODICE (CODE)	O.E. (OR. NUM.)	Ø RULLO (ROLLER)	H. RULLO (ROLLER)	H. TOT. (TOT.)	N. DENTI (TEETH)
AVANTIME (T.T.)	09/01 > 05/06	660700	7700111779 7700113959	29,95	12	24	29
CLIO I - II (T.T.)	05/90 > 05	660700	7700111779 7700113959	29,95	12	24	29
ESPACE I - II (T.T.)	03/88 > 10/96	660700	7700111779 7700113959	29,95	12	24	29
KANGOO (1,5 dCl - 1,9 dCl)	12/01 >	660700	7700111779 7700113959	29,95	12	24	29
LAGUNA I (2,0)	06/95 > 02/01	660700	7700111779 7700113959	29,95	12	24	29
MASTER II (T.T.)	11/97 > 01/10	660400	7701056151	37	12,3	28	25
MEGANE I (T.T.)	01/95 > 08/03	660700	7700111779 7700113959	29,95	12	24	29
TRAFIC II (T.T.)	04/01 > 08/06	660400	7701056151	37	12,3	28	25
TWINGO I (1,2 16v.)	08/04 > 06/07	660700	7700111779 7700113959	29,95	12	24	29

N.B.: I CODICI O.E. ED IL LORO TESTO SONO RIPORTATI SOLO A TITOLO INDICATIVO
THE O.E. CODES AND THEIR TEXT ARE REPORTED ONLY FOR INDICATIVE PURPOSE

APPLICAZIONE (APPLICATION)	ANNO (YEAR)	CODICE (CODE)	O.E. (OR. NUM.)	Ø RULLO (ROLLER)	H. RULLO (ROLLER)	H. TOT. (TOT.)	N. DENTI (TEETH)
740 (2,4 D)	08/84 > 07/92	660302	8603259 36000557 36001360	33,9	11,8	26,6	23
C30 (T.T.)	10/06 > 12/12	660302	8603259 36000557 36001360	33,9	11,8	26,6	23
S70 (T.T.)	01/97 > 11/00	660302	8603259 36000557 36001360	33,9	11,8	26,6	23
S90 I (T.T.)	01/97 > 05/98	660302	8603259 36000557 36001360	33,9	11,8	26,6	23
V50 (T.T.)	04/04 > 12/12	660302	8603259 36000557 36001360	33,9	11,8	26,6	23
V60 I (T.T.)	02/11 > 12/15	660302	8603259 36000557 36001360	33,9	11,8	26,6	23
XC60 I (T.T.)	05/08 > 02/17	660302	8603259 36000557 36001360	33,9	11,8	26,6	23
XC90 I (T.T.)	04/09 > 12/14	660302	8603259 36000557 36001360	33,9	11,8	26,6	23

N.B.: I CODICI O.E. ED IL LORO TESTO SONO RIPORTATI SOLO A TITOLO INDICATIVO
THE O.E. CODES AND THEIR TEXT ARE REPORTED ONLY FOR INDICATIVE PURPOSE

IMMAGINI - IMAGES

66112



660100



660101



660202



660203



660204



660205



660206



660207



660208

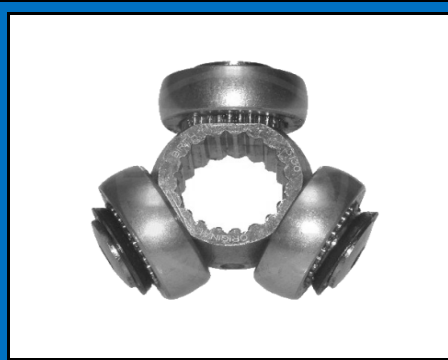

660209

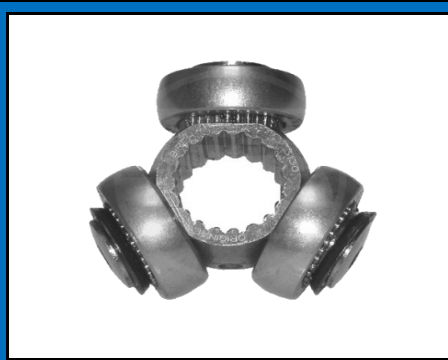

660210



N.B.: I CODICI O.E. ED IL LORO TESTO SONO RIPORTATI SOLO A TITOLO INDICATIVO
 THE O.E. CODES AND THEIR TEXT ARE REPORTED ONLY FOR INDICATIVE PURPOSE

IMMAGINI - IMAGES

660214



660215



660216



660217



660218



660219



660220



660221



660222



660223



660224



660225



N.B.: I CODICI O.E. ED IL LORO TESTO SONO RIPORTATI SOLO A TITOLO INDICATIVO
 THE O.E. CODES AND THEIR TEXT ARE REPORTED ONLY FOR INDICATIVE PURPOSE

IMMAGINI - IMAGES

660300



660301



660302



660303



660400



660600



660601



660700



660701



660900



660902



66H06



N.B.: I CODICI O.E. ED IL LORO TESTO SONO RIPORTATI SOLO A TITOLO INDICATIVO
 THE O.E. CODES AND THEIR TEXT ARE REPORTED ONLY FOR INDICATIVE PURPOSE

CROCIERE CARDANICHE
CARDAN CRUISER

JapKo[®]

APPLICAZIONE (APPLICATION)	ANNO (YEAR)	CODICE (CODE)	O.E. (OR. NUM.)	Ø RULLO (ROLLER)	L1 LUNGH. (LENGTH)	L2 LUNGH. (LENGTH)
BLAZER (S10) (2,5 TD - 2,8 - 4,3)	09/82 > 12/94	66005	4723072	27	82	60,3
BLAZER (S10) (2,8 - 4,3)	09/82 > 12/94	66W00	12479126	28,6	93	60
BLAZER (S10) (4,3)	01/94 > 09/05	66W01	26008858	27	82,5	58
BLAZER (K5) (5,7)	09/83 > 12/89	66014				
BLAZER (K5) (5,7)	09/83 > 12/86	66018		30,18	92,05	
BLAZER (K5) (5,7 - 6,2 D)	10/84 > 09/96	66015				
TAHOE (B2W) (5,3)	12/99 >	66W00	12479126	28,6	93	60
TRAIBLAZER (KC) (4,2)	09/01 > 09/08	66W00	12479126	28,6	93	60
TRAIBLAZER (KC) (4,2)	09/01 > 09/08	66W01	26008858	27	82,5	58

N.B.: I CODICI O.E. ED IL LORO TESTO SONO RIPORTATI SOLO A TITOLO INDICATIVO
THE O.E. CODES AND THEIR TEXT ARE REPORTED ONLY FOR INDICATIVE PURPOSE

APPLICAZIONE (APPLICATION)	ANNO (YEAR)	CODICE (CODE)	O.E. (OR. NUM.)	Ø RULLO (ROLLER)	L1 LUNGH. (LENGTH)	L2 LUNGH. (LENGTH)
C/MAX II (1,6 Ti)	12/10 > 06/19	660208		35	99	
C/MAX II (1,6 Ti)	12/10 > 06/19	660209		26	67	42
C/MAX II (1,6 Ti)	12/10 > 06/19	66912		29	77	50
F150 PICK UP (4,2 - 4,6 - 5,4)	10/96 > 11/03	66016	1634897	27	92	71,2
SIERRA II (T.T.)	01/87 > 02/93	66L03	1634897	23,84	61,83	
RANGER (ER - EQ) (2,5 D - TD) - (ASSE ANTERIORE)	06/99 > 07/06	66303	1454601 1772723	27	82	
RANGER (ER - EQ) (2,5 TD) - (ASSE POSTERIORE)	04/02 >	66300	1530041	27	92	67,5
RANGER (ET) (2,5 TDCI) - (ASSE ANTERIORE)	05/06 > 07/12	66303	1454601 1772723	27	82	
RANGER (ET) (2,5 TDCI) - (ASSE POSTERIORE)	05/06 > 07/12	66302	1454602 1772724	27	92	

N.B.: I CODICI O.E. ED IL LORO TESTO SONO RIPORTATI SOLO A TITOLO INDICATIVO
THE O.E. CODES AND THEIR TEXT ARE REPORTED ONLY FOR INDICATIVE PURPOSE

APPLICAZIONE (APPLICATION)	ANNO (YEAR)	CODICE (CODE)	O.E. (OR. NUM.)	Ø RULLO (ROLLER)	L1 LUNGH. (LENGTH)	L2 LUNGH. (LENGTH)
GALLOPER II (JK-01) (2,5 TCI D) - (ASSE ANTERIORE)	08/98 > 12/03	66H00	4914043001 491404A500	27	80	
GALLOPER II (JK-01) (2,5 TCI D - 2,5 TDI) - (ASSE ANTER.)	08/98 > 12/03	66H01	SB000055A S2000055A	27	62	
H-1 FURGONATO (A1) (2,5 TD) - (ASSE ANTERIORE)	10/01 > 08/07	66H00	4914043001 491404A500	27	80	
H-1 FURGONATO (A1) (2,5 CRDI) - (ASSE ANTERIORE)	08/03 > 12/07	66H04	491404A400 491404A500	16	41	
H-1 STAREX AUTOBUS (A1) (2,5 TD) - (ASSE ANTERIORE)	06/97 > 04/04	66H04	491404A400 491404A500	16	41	
H100 (P) (2,5 TD) - (ASSE ANTERIORE)	07/93 > 12/00	66H00	4914043001 491404A500	27	80	
SANTA FE' I (SM) (2,0 CRD - 2,4 - 2,7) - (ASSE ANTER.)	07/93 > 12/00	66H00	4914043001 491404A500	27	80	
STELLAR (F31 - SF2) (1,6) - (ASSE ANTERIORE)	10/83 > 12/91	66H01	SB000055A S2000055A	27	62	
TERRACAN (HP) (2,9 CRD) - (ASSE ANTERIORE)	11/03 > 12/06	66H01	SB000055A S2000055A	27	62	
TUCSON (JM) (T.T.)	08/04 > 11/10	66H07	*493002E000 *495982E000	26,5	48	

N.B.: I CODICI O.E. ED IL LORO TESTO SONO RIPORTATI SOLO A TITOLO INDICATIVO
THE O.E. CODES AND THEIR TEXT ARE REPORTED ONLY FOR INDICATIVE PURPOSE

APPLICAZIONE (APPLICATION)	ANNO (YEAR)	CODICE (CODE)	O.E. (OR. NUM.)	Ø RULLO (ROLLER)	L1 LUNGH. (LENGTH)	L2 LUNGH. (LENGTH)
D-MAX I (TFR - TFS) (2,5 DITD)	10/02 > 06/12	66912	8979428450	29	77	50
D-MAX I (TFR - TFS) (2,5 DITD - 3,0 DITD)	01/07 > 06/12	66901	8970718120 8970718121	29	78	50
D-MAX I (TFR - TFS) (2,5 DITD - 3,0 DITD)	01/07 > 06/12	66902	8979451020 8979476450	29	96	70
D-MAX II (TFR - TFS) (2,5 CRDI)	06/12 > 12/18	66914	8979451010 8979475820	29	77	53
ELF (NHR6 - NKR6 - NKR7) (DITD)	10/99 > 09/03	66800	94027724 94479053	24	62	
SERIE N (NKR69S - NPR69L/M) (DIESEL)	01/98 > 12/01	66906	8970805050 8970805051	33	94	
SERIE N (NPR55/65/69/77) (2,8 TD - 3,0 D - 4,0 D)	01/97 >	66907	8973227490 8980336051	33	104	
TROOPER (UBS) (2,2 D)	05/84 > 12/89	66800	94027724 94479053	24	62	
TROOPER III (3,0 DTI - 3,5 V6)	05/98 > 08/04	66200		29	77	49
TROOPER III (3,5 V6 24v.)	04/00 > 08/04	66904	897029526 8970718120 8970718121	29	76	50
TROOPER III (3,5 V6 24v.)	04/00 > 08/04	66908	8971673170	29	96	70

N.B.: I CODICI O.E. ED IL LORO TESTO SONO RIPORTATI SOLO A TITOLO INDICATIVO
THE O.E. CODES AND THEIR TEXT ARE REPORTED ONLY FOR INDICATIVE PURPOSE

APPLICAZIONE (APPLICATION)	ANNO (YEAR)	CODICE (CODE)	O.E. (OR. NUM.)	Ø RULLO (ROLLER)	L1 LUNGH. (LENGTH)	L2 LUNGH. (LENGTH)
CHEROKEE (XJ) (2,1 TD - 4,0i)	10/84 > 09/01	66005	4723072	27	82	60,3
CHEROKEE (XJ) (2,1 TD - 4,0i)	10/84 > 09/01	66006	4137757 8126638	30	82	53
CHEROKEE (XJ) (2,1 TD - 2,5 TD - 4,0i)	10/84 > 09/01	66098	KJ8126637	27	82	53
CHEROKEE (XJ) (2,1 TD - 4,0i) - (ASSE POSTERIORE)	10/84 > 09/01	66007	4505575	28,6	94	62
CHEROKEE (XJ) (2,5i - 2,5 TD - 4,0i) - (ASSE POSTER.)	01/88 > 09/01	66099	KJ8126614	27	82	52,5
CHEROKEE (XJ) (4,0i) - (ASSE POSTERIORE)	01/95 > 09/01	66108	371253X00A	27	92	
CHEROKEE (KJ) (2,5 CRD - 2,8 CRD - 3,7)	09/01 > 01/08	66098	KJ8126637	27	82	53
CHEROKEE (KJ) (2,5 CRD - 2,8 CRD - 3,7) - (POSTER.)	09/01 > 01/08	66099	KJ8126614	27	82	52,5
CHEROKEE (KJ) (2,5 CRD) - (POSTERIORE)	09/01 > 01/08	66302	04746936 05014062AA	27	92	
CJ3 - CJ5 (T.T.)	68 > 73	66017		25,5 - 27	62,2	44,3
GRAN CHEROKEE I (ZJ - ZG) (2,5 TD - 4,0i - 5,2i)	10/95 > 04/99	66005	4723072	27	82	60,3
GRAN CHEROKEE I (ZJ - ZG) (2,5 TD - 4,0i - 5,2i)	10/84 > 09/01	66006	4137757 8126638	30	82	53
GRAN CHEROKEE I (ZJ - ZG) (2,5 TD - 5,9i)	10/84 > 09/01	66098	KJ8126637	27	82	53
GRAN CHEROKEE I (ZJ - ZG) (2,5 TD - 4,0i - 5,2i) - (ASSE POSTER.)	10/84 > 09/01	66007	4505575	28,6	94	62
GRAN CHEROKEE I (ZJ - ZG) (5,9i) - (POSTERIORE)	08/97 > 04/99	66302	04746936 05014062AA	27	92	
GRAN CHEROKEE II (WJ - WG) (2,7 CRD - 3,1 TD - 4,0 - 4,7) - (POSTER.)	04/99 > 09/05	66099	KJ8126614	27	82	52,5

N.B.: I CODICI O.E. ED IL LORO TESTO SONO RIPORTATI SOLO A TITOLO INDICATIVO
THE O.E. CODES AND THEIR TEXT ARE REPORTED ONLY FOR INDICATIVE PURPOSE

APPLICAZIONE (APPLICATION)	ANNO (YEAR)	CODICE (CODE)	O.E. (OR. NUM.)	Ø RULLO (ROLLER)	L1 LUNGH. (LENGTH)	L2 LUNGH. (LENGTH)
WILLIS (2,2)	01/50 > 12/58	66916		27	82	62,7
WRANGLER I (YJ - SY) (2,5 - 4,0)	12/91 > 08/96	66005	4723072	27	82	60,3
WRANGLER I (YJ - SY) (2,5 - 4,0)	12/91 > 08/96	66006	4137757 8126638	30	82	53
WRANGLER I (YJ - SY) (2,5 - 4,0)	12/91 > 08/96	66098	KJ8126637	27	82	53
WRANGLER I (YJ - SY) (4,0) - (ASSE POSTERIORE)	12/91 > 08/96	66099	KJ8126614	27	82	52,5
WRANGLER II (TJ) (2,5 - 4,0)	08/96 > 04/07	66006	4137757 8126638	30	82	53
WRANGLER II (TJ) (2,5 - 4,0) - (ASSE POSTERIORE)	08/96 > 04/07	66099	KJ8126614	27	82	52,5

N.B.: I CODICI O.E. ED IL LORO TESTO SONO RIPORTATI SOLO A TITOLO INDICATIVO
THE O.E. CODES AND THEIR TEXT ARE REPORTED ONLY FOR INDICATIVE PURPOSE

APPLICAZIONE (APPLICATION)	ANNO (YEAR)	CODICE (CODE)	O.E. (OR. NUM.)	Ø RULLO (ROLLER)	L1 LUNGH. (LENGTH)	L2 LUNGH. (LENGTH)
323 III (BF) (1,6 GT - GT TURBO)	08/87 > 10/89	66304	025989251	25	64	40
323 IV (BG) (1,8 16v. TURBO)	01/93 > 07/94	66304	025989251	25	64	40
626 III (GD - GV) (2,0 - 2,2)	11/87 > 07/91	66304	025989251	25	64	40
626 IV (GE) (2,0i)	04/92 > 04/97	66304	025989251	25	64	40
626 V (GG) (2,3 TURBO)	12/05 > 08/07	66301	P00325060A	24	74	
929 III (HC) (2,2 12v.)	04/89 > 06/91	66305	060489251A 8BW125060	28	80	53
B-SERIE (UF) (2,0 - 2,2 D - 2,5 D - 2,6 i)	01/85 > 03/96	66305	060489251A 8BW125060	28	80	53
B-SERIE (UF) (T.T.)	01/85 > 03/96	66305	060489251A 8BW125060	28	80	53
B-SERIE (UF) (2,5 D)	09/98 > 06/99	66300	8BS225060B P03325060B	27	92	67,5
B-SERIE (UN) (2,5 D)	06/99 > 11/06	66300	8BS225060B P03325060B	27	92	67,5
B-SERIE (UN) (2,5 D - 2,5 TD)	06/99 > 11/06	66099		27	82	52,5
B-SERIE (UN) (2,5 - 2,5 D - 2,6i)	06/99 > 07/06	66305	060489251A 8BW125060	28	80	53
B-SERIE (UN) (2,5 TD 4WD)	06/99 > 07/06	66303	SA672506X	27	82	
BT-50 PICK-UP (CD - UN) (2,5 MRZ-CD) - (ANTERIORE)	08/06 > 12/15	66303	SA672506X	27	82	
BT-50 PICK-UP (CD - UN) (2,5 MRZ-CD) - (LONGITUDINALE)	08/06 > 12/15	66305	060489251A 8BW125060	28	80	53
BT-50 PICK-UP (CD - UN) (2,5 MRZ-CD) - (POSTERIORE)	08/06 > 12/15	66302	SA122506X SA682506X	27	92	

N.B.: I CODICI O.E. ED IL LORO TESTO SONO RIPORTATI SOLO A TITOLO INDICATIVO
THE O.E. CODES AND THEIR TEXT ARE REPORTED ONLY FOR INDICATIVE PURPOSE

APPLICAZIONE (APPLICATION)	ANNO (YEAR)	CODICE (CODE)	O.E. (OR. NUM.)	Ø RULLO (ROLLER)	L1 LUNGH. (LENGTH)	L2 LUNGH. (LENGTH)
L200 (K0 - K1 - K2 - K3) (2,0 - 2,5 D - 2,5 TD - 2,6) - (ASSE ANT.)	11/86 > 08/96	66500	MB000393 MR196837	25	64	
L200 (K0 - K1 - K2 - K3) (2,0 - 2,5 D - 2,5 TD - 2,6) - (ASSE POST.)	11/86 > 08/96	66501	MB000823 MB000948 MR196838	25	77	
L200 (K5 - K6 - K7) (2,4 - 2,5 TD) - (ASSE ANTERIORE)	06/96 > 12/07	66500	MB000393 MR196837	25	64	
L200 (K5 - K6 - K7) (2,4 - 2,5 TD) - (ASSE ANTERIORE)	06/96 > 12/07	66801		25	64	40
L200 (K5 - K6 - K7) (2,4 - 2,5 TD) - (ASSE POSTERIORE)	06/96 > 12/07	66502	MC834855 MC994292	30	85	57
L200 (KA - KB) (2,5 DI-D) - (ASSE POSTERIORE)	11/05 > 12/15	66503	MR165561 MR377128	30	101	71
L300 II (LO3) (1,6 - 1,8 - 2,0) - (ASSE ANTERIORE)	11/84 > 02/87	66500	MB000393 MR196837	25	64	
L300 II (LO3) (1,6 - 1,8 - 2,0) - (ASSE POSTERIORE)	11/84 > 02/87	66501	MB000823 MB000948 MR196838	25	77	
L300 III (P0 - P1 - P2 - P3) (1,6 - 2,0 - 2,4 - 2,5 TD) - (ASSE ANT.)	11/86 > 05/94	66500	MB000393 MR196837	25	64	
L400 (PA - PB - PC - PD) (2,4 - 2,4i - 2,5 TD) - (ASSE ANTERIORE)	05/95 > 06/05	66500	MB000393 MR196837	25	64	
L400 (PA - PB - PC - PD) (2,4 - 2,4i - 2,5 TD) - (ASSE POSTER.)	05/95 > 06/05	66501	MB000823 MB000948 MR196838	25	77	
CANTER (E3) (3,9 TDI)	10/96 > 07/01	66506	MC994294 MK996631	31,7	102	
GALANT IV (E3) (2,0 GTI 16v.)	07/89 > 12/92	66500	MB000393 MR196837 MB154554	25	64	
LANCER III (C1 - C3) (1,8)	01/87 > 08/89	66500	MB000393 MR196837 MB154554	25	64	
LANCER IV (C6 - C7) (1,8)	09/89 > 06/92	66500	MB000393 MR196837 MB154554	25	64	
LANCER V (CB - CD - CE) (1,6 - EVO II - EVO III)	01/94 > 07/96	66500	MB000393 MR196837 MB154554	25	64	

N.B.: I CODICI O.E. ED IL LORO TESTO SONO RIPORTATI SOLO A TITOLO INDICATIVO
THE O.E. CODES AND THEIR TEXT ARE REPORTED ONLY FOR INDICATIVE PURPOSE

APPLICAZIONE (APPLICATION)	ANNO (YEAR)	CODICE (CODE)	O.E. (OR. NUM.)	Ø RULLO (ROLLER)	L1 LUNGH. (LENGTH)	L2 LUNGH. (LENGTH)
LANCER VI (CJ - CP) (EVO V - EVO VI)	01/98 > 12/01	66500	MB000393 MR196837 MB154554	25	64	
OUTLANDER I (CU) (2,0 - 2,4)	01/02 > 09/07	66500	MB000393 MR196837 MB154554	25	64	
PAJERO I (LO4 - L14) (2,5 TD - 3,0 V6) - (ASSE ANTERIORE)	11/88 > 11/90	66500	MB000393 MR196837 MB154554	25	64	
PAJERO I (LO4 - L14) (2,5 TD - 3,0 V6) - (ASSE POSTERIORE)	11/88 > 11/90	66501	MB000823 MB000948 MR196838	25	77	
PAJERO I (LO4 - L14) (2,5 TD - 3,0 V6) - (ASSE POSTERIORE)	11/88 > 11/90	66502	MC834855 MC994292	30	85	57
PAJERO II (V2 - V3 - V4 - V5) (2,4 - 2,5 TD - 2,6 - 3,0) - (ASSE ANT.)	12/90 > 10/99	66500	MB000393 MR196837 MB154554	25	64	
PAJERO II (V2 - V3 - V4 - V5) (2,4 - 2,5 TD - 2,6 - 3,0) - (ASSE POST.)	12/90 > 10/99	66501	MB000823 MB000948 MR196838	25	77	
PAJERO II (V2 - V3 - V4 - V5) (2,4 - 2,5 TD - 2,6 - 3,0) - (ASSE POST.)	12/90 > 10/99	66502	MC834855 MC994292	30	85	57
PAJERO II (V2 - V3 - V4 - V5) (2,8 TD) - (ASSE POSTERIORE)	06/94 > 10/99	66503	MR165561 MR377128	30	101	71
PAJERO II (V2 - V4) (1,8 GDI) - (ASSE POSTERIORE)	06/98 > 04/00	66505	MR580197	27	76	
PAJERO II (V3) (3,2 DI-D) - (ASSE ANTERIORE)	04/00 > 09/07	66500	MB000393 MR196837 MB154554	25	64	
PAJERO II (V3) (3,2 DI-D) - (ASSE POSTERIORE)	04/00 > 09/07	66501	MB000823 MB000948 MR196838	25	77	
PAJERO III (V6 - V7) (2,5 TDI - 3,2 DI-D) - (ASSE ANTER.)	04/00 > 12/06	66500	MB000393 MR196837 MB154554	25	64	
PAJERO III (V6 - V7) (2,5 TDI - 3,2 DI-D) - (ASSE POSTER.)	04/00 > 12/06	66501	MB000823 MB000948 MR196838	25	77	
PAJERO PININ I (H6 - H7) (1,8) - (ASSE POSTERIORE)	11/01 > 06/07	66505	MR580197	27	76	
SPACE RUNNER (N1 - N2) (1,8)	10/91 > 08/99	66500	MB000393 MR196837 MB154554	25	64	

N.B.: I CODICI O.E. ED IL LORO TESTO SONO RIPORTATI SOLO A TITOLO INDICATIVO
THE O.E. CODES AND THEIR TEXT ARE REPORTED ONLY FOR INDICATIVE PURPOSE

APPLICAZIONE (APPLICATION)	ANNO (YEAR)	CODICE (CODE)	O.E. (OR. NUM.)	Ø RULLO (ROLLER)	L1 LUNGH. (LENGTH)	L2 LUNGH. (LENGTH)
CABSTAR (F22) (2,5 D)	01/83 >	66111	3712576000	25	80,6	52
CABSTAR (F24) (MOT. dCl)	09/06 > 12/13	66107	371252X801	27	75,5	
NAVARA NP300 (D40) (2,5 dCl)	09/06 > 12/13	66107	371252X801	27	75,5	
NAVARA NP300 (D40) (2,5 dCl) - (ASSE POSTERIORE)	09/06 > 12/13	66108	371253X00A	27	92	
PATHFINDER III (R51) (2,5 dCl - 4,0)	01/05 >	66107	371252X801	27	75,5	
PATHFINDER III (R51) (2,5 dCl - 4,0)	09/05 >	66109	37125EB30A C7125EB30A	27	82	
PATHFINDER III (R51) (2,5 dCl - 4,0) - (ASSE POSTERIORE)	01/05 >	66108	371253X00A	27	92	
PATROL III (3,3 D)	11/79 > 08/88	66102	37125C9425 37126C9425	28	81	53
PATROL GR IV (Y60 - GR) (2,8 TD)	09/88 > 06/97	660101	3712601G25 3712601G26	27	71	46
PATROL GR IV (Y60 - GR) (2,8 TD)	09/88 > 06/97	66102	37125C9425 37126C9425	28	81	53
PATROL GR V (Y61) (2,8 TD - 3,0 Dti)	06/97 >	66102	37125C9425 37126C9425	28	81	53
PATROL GR V (Y61) (2,8 TD - 3,0 Dti)	06/97 >	66104	3712501J25 C712501J25	32	98	65
PICK UP (D21) (2,5 D)	08/87 > 02/98	66801	3712649W26 3712514626 3712514627	25	64	40
PICK UP (D21) (2,5 D)	03/86 > 08/91	660101	3712601G25 3712601G26	27	71	46
PICK UP (D21) (2,5 D)	08/87 > 02/98	66102	37125C9425 37126C9425	28	81	53
PICK UP (D22) (2,5 Di)	03/02 > 12/10	66102	37125C9425 37126C9425	28	81	53

N.B.: I CODICI O.E. ED IL LORO TESTO SONO RIPORTATI SOLO A TITOLO INDICATIVO
THE O.E. CODES AND THEIR TEXT ARE REPORTED ONLY FOR INDICATIVE PURPOSE

APPLICAZIONE (APPLICATION)	ANNO (YEAR)	CODICE (CODE)	O.E. (OR. NUM.)	Ø RULLO (ROLLER)	L1 LUNGH. (LENGTH)	L2 LUNGH. (LENGTH)
PICK UP (D22) (2,5 Di)	03/02 > 12/10	66801	3712649W26 3712514626 3712514627	25	64	40
TERRANO I (WD21) (2,7 TD)	02/89 > 02/96	66801	3712649W26 3712514626 3712514627	25	64	40
TERRANO I (WD21) (2,7 TD - 3,0i)	02/89 > 02/96	660101	3712601G25 3712601G26	27	71	46
TERRANO I (WD21) (2,7 TD - 3,0i)	02/89 > 02/96	66102	37125C9425 37126C9425	28	81	53
TERRANO II (R20) (2,4i - 2,7 TD - TDi)	02/93 > 01/02	66105	371257F025	27	82	
TERRANO II (R20) (2,7 TD - 2,7 TDI - 3,0 Di)	02/93 > 09/07	66110	371252X800	25	65	53,8
TERRANO II (R20) (3,0 Di)	05/02 > 09/07	66107	371252X801	27	75,5	
TRADE (2,8 D - 3,0 D)	12/86 > 10/98	66103	371257F025	27	85	
TRADE FURGONATO (2,0 D)	11/86 > 03/93	66800	94027724 94479053	24	62	

N.B.: I CODICI O.E. ED IL LORO TESTO SONO RIPORTATI SOLO A TITOLO INDICATIVO
THE O.E. CODES AND THEIR TEXT ARE REPORTED ONLY FOR INDICATIVE PURPOSE

APPLICAZIONE (APPLICATION)	ANNO (YEAR)	CODICE (CODE)	O.E. (OR. NUM.)	Ø RULLO (ROLLER)	L1 LUNGH. (LENGTH)	L2 LUNGH. (LENGTH)
CAMPO (TF0 - TF1) (3,1 TD 4X4)	10/84 > 09/01	66005	3311501000	27	82	60,3
CAMPO (TF0 - TF1) (2,5 D 4X4)	08/91 > 06/94	66200		29	77	49
CAMPO (TF0 - TF1) (2,5 D 4X4)	08/91 > 06/94	66901	8970718120 8970718121	29	78	50
CAMPO (TF0 - TF1) (2,5 D - 3,1 TD)	08/91 > 06/01	66905		29	77	51
CAMPO (TF0 - TF1) (3,1 TD)	12/92 > 06/01	66W00	12479126	28,6	93	60
FRONTERA A (T.T.)	03/92 > 10/98	66107		27	75,5	
FRONTERA B (T.T.)	09/98 > 07/04	66107		27	75,5	

N.B.: I CODICI O.E. ED IL LORO TESTO SONO RIPORTATI SOLO A TITOLO INDICATIVO
THE O.E. CODES AND THEIR TEXT ARE REPORTED ONLY FOR INDICATIVE PURPOSE

APPLICAZIONE (APPLICATION)	ANNO (YEAR)	CODICE (CODE)	O.E. (OR. NUM.)	Ø RULLO (ROLLER)	L1 LUNGH. (LENGTH)	L2 LUNGH. (LENGTH)
CARRY FURGONATO (0S) (0,8)	11/80 > 10/85	66804	2720060512	20	61	
GRAN VITARA I (FT - HT) (2,0 HDI)	02/01 > 12/03	66802	2720066810 27200538300	26	71	
GRAN VITARA I (FT - HT) (1,6 - 2,0 - 2,0 HDI) - (ASSE POST.)	03/98 > 12/03	66805	2720083000 2720083010	25	64	
GRAN VITARA II (JT - TE - TD) (1,6 - 1,9 DDIS - 2,0)	04/05 > 12/15	66802	2720066810 27200538300	26	71	
JIMNY (SN) (1,3 - 1,5 DDIS) - (ASSE POST.)	02/01 >	66805	2720083000 2720083010	25	64	
SAMURAI (SJ) (1,0)	11/88 > 12/04	66801	2720073813	25	64	40
SAMURAI (SJ) (1,0 - 1,3) - (ASSE POST.)	02/01 >	66805	2720083000 2720083010	25	64	
SAMURAI (SJ) (1,3 - 1,9 TD)	11/88 > 12/04	66800	2720085C00	24	62	
SJ 410 (OS) (1,0)	09/81 > 07/91	66801	2720073813	25	64	40
SUPER CARRY (ED) (1,0)	10/92 > 03/99	66806	271006700	20	58	36,5
VITARA (ET - TA - TD) (1,6i - 1,9 D)	07/90 > 03/99	66800	2720085C00	24	62	
VITARA (ET - TA - TD) (1,6i - 1,9 D - 2,0 TD) - (ASSE POST.)	07/88 > 03/98	66805	2720083000 2720083010	25	64	

APPLICAZIONE (APPLICATION)	ANNO (YEAR)	CODICE (CODE)	O.E. (OR. NUM.)	Ø RULLO (ROLLER)	L1 LUNGH. (LENGTH)	L2 LUNGH. (LENGTH)
4 RUNNER II (3,0 D)	01/90 > 10/95	66200	0437160060 0437136011	29	77	49
CELICA COUPE' (T18) (3,0 D)	10/89 > 11/93	66200	0437160060 0437136011	29	77	49
COROLLA (KE) (1,2)	10/72 > 07/79	66204	0437110011	20	58	
COROLLA (E7) (1,3)	09/79 > 06/83	66204	0437110011	20	58	
DYNA (4,0 D-4D)	10/06 >	66206	0437137080	33	96,5	
DYNA 250 (4,6 TDI)	06/03 > 12/03	66208	0437137011	35	99	
DYNA 400 (4,6 TDI)	06/03 > 09/06	66208	0437137011	35	99	
HIACE IV (2,4 D)	08/89 > 12/04	66200	0437160060 0437136011	29	77	49
HIACE IV (2,4 D)	08/95 > 12/04	66201	0437125010	26	80	53,5
HILUX III (2,0)	01/79 > 07/83	66205	0437135070 043710K110	29	77	49,5
HILUX V (2,4 D)	09/88 > 12/97	66200	0437160060 0437136011	29	77	49
HILUX VI (2,4 TD - 2,5 D-4D)	11/05 > 07/05	66200	0437160060 0437136011	29	77	49
HILUX VI (2,5 D-4D)	11/05 > 07/05	66205	0437135070 043710K110	29	77	49,5
HILUX VII (2,5 D-4D + 3,0 D-4D)	03/05 > 05/15	66205	0437135070 043710K110	29	77	49,5
HILUX VII (2,5 D-4D + 3,0 D-4D)	03/05 > 05/15	66207	043750K012	27	83	
LAND CRUISER (2,4 D - 2,4 TD - 3,0 TD)	11/84 > 05/96	66200	0437160060 0437136011	29	77	49

N.B.: I CODICI O.E. ED IL LORO TESTO SONO RIPORTATI SOLO A TITOLO INDICATIVO
THE O.E. CODES AND THEIR TEXT ARE REPORTED ONLY FOR INDICATIVE PURPOSE

APPLICAZIONE (APPLICATION)	ANNO (YEAR)	CODICE (CODE)	O.E. (OR. NUM.)	Ø RULLO (ROLLER)	L1 LUNGH. (LENGTH)	L2 LUNGH. (LENGTH)
LAND CRUISER (3,4 D)	11/84 > 12/96	66202	0437136020 0437136030	32	95	61
LAND CRUISER (4,0 TD)	10/85 > 12/89	66202	0437136020 0437136030	32	95	61
LAND CRUISER (4,0 TD)	10/85 > 12/89	66204	0437110011	20	58	
LAND CRUISER 80 (4,2 TD - 4,5 24v.)	01/90 > 12/97	66200	0437160060 0437136011	29	77	49
LAND CRUISER 80 (4,2 TD - 4,5 24v.)	01/90 > 12/97	66202	0437136020 0437136030	32	95	61
LAND CRUISER 90 (2,7)	04/96 > 12/02	66209	0437122010	26	67	42
LAND CRUISER 90 (3,0 D - 3,0 TD)	04/96 > 12/02	66200	0437160060 0437136011	29	77	49
LAND CRUISER 100 (4,2 TD - 4,7)	01/90 > 12/97	66200	0437160060 0437136011	29	77	49
LAND CRUISER PRADO (3,0 D)	09/02 > 12/10	66200	0437160060 0437136011	29	77	49
MODEL F (CR2 - YR2 - YR3) (1,8 - 2,0 - 2,0 D)	11/82 > 01/90	66209	0437122010	26	67	42
STARLET (KP6) (1,0 - 1,2 - 1,3)	02/78 > 09/84	66204	0437110011	20	58	
STARLET 1000 (KP) (1,0)	11/74 > 08/78	66204	0437110011	20	58	
SUPRA (A7 - A8) (3,0 TURBO)	09/87 > 07/02	66200	0437160060 0437136011	29	77	49

N.B.: I CODICI O.E. ED IL LORO TESTO SONO RIPORTATI SOLO A TITOLO INDICATIVO
THE O.E. CODES AND THEIR TEXT ARE REPORTED ONLY FOR INDICATIVE PURPOSE

IMMAGINI - IMAGES

66005

66006

66007

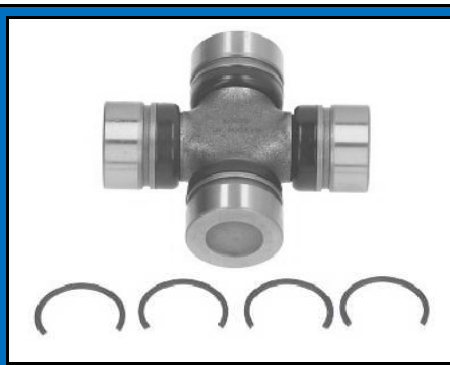

66011

66012

66013

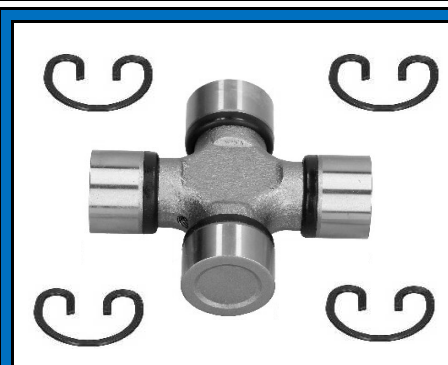

66014

66015

66016

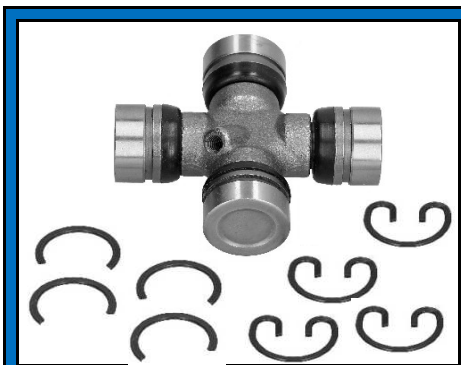

66017

66018

66019



N.B.: I CODICI O.E. ED IL LORO TESTO SONO RIPORTATI SOLO A TITOLO INDICATIVO
 THE O.E. CODES AND THEIR TEXT ARE REPORTED ONLY FOR INDICATIVE PURPOSE

IMMAGINI - IMAGES

66098

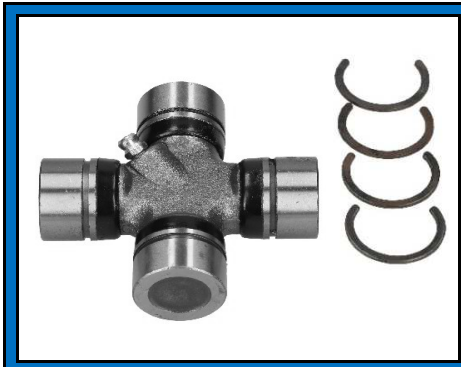

66099

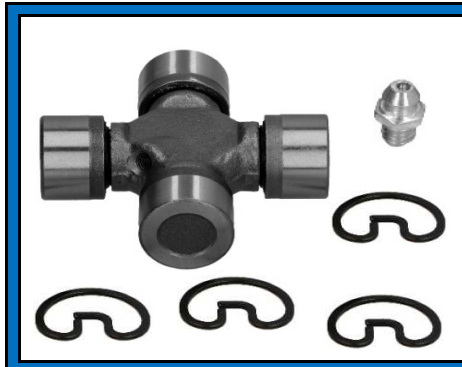

660213

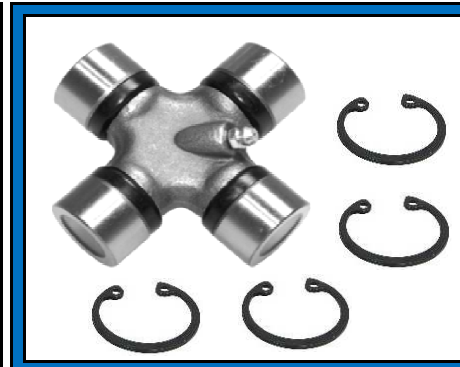

66500



660702



66101

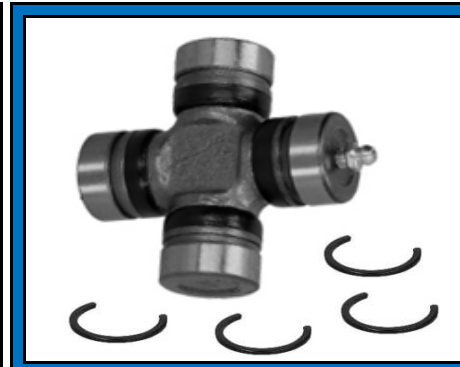

66102

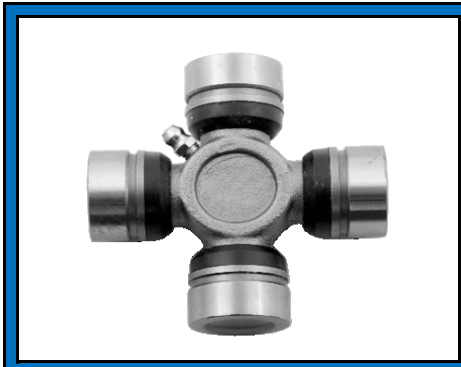

66103



66104



66105

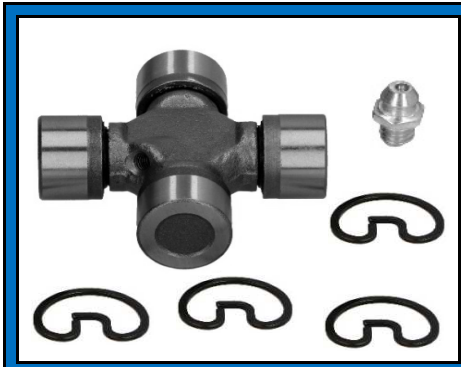

66107

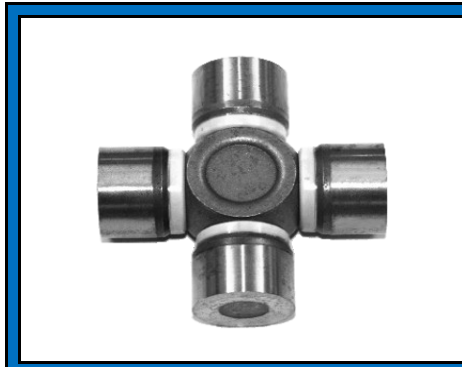

66108

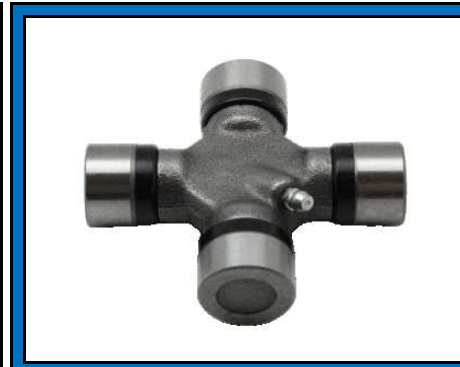

N.B.: I CODICI O.E. ED IL LORO TESTO SONO RIPORTATI SOLO A TITOLO INDICATIVO
 THE O.E. CODES AND THEIR TEXT ARE REPORTED ONLY FOR INDICATIVE PURPOSE

IMMAGINI - IMAGES

66109

66110

66111

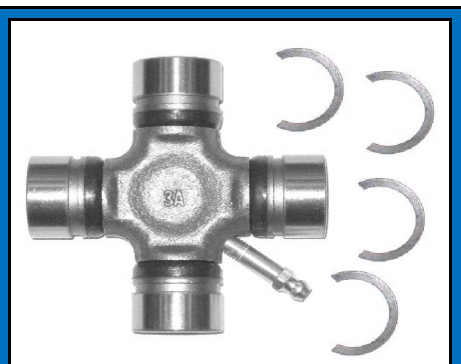

66200

66201

66202



66204

66205

66206

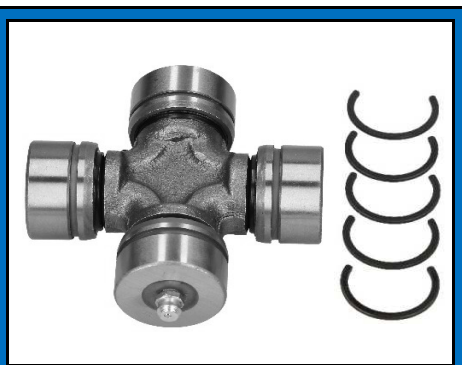

66207

66208

66209



N.B.: I CODICI O.E. ED IL LORO TESTO SONO RIPORTATI SOLO A TITOLO INDICATIVO
 THE O.E. CODES AND THEIR TEXT ARE REPORTED ONLY FOR INDICATIVE PURPOSE

IMMAGINI - IMAGES

66300



66301



66302



66303

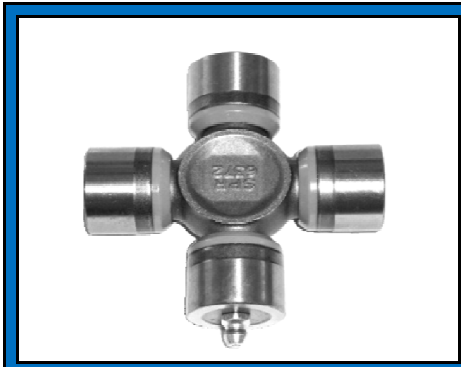

66304

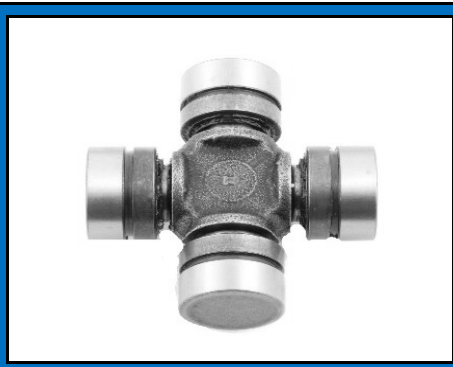

66305



66400

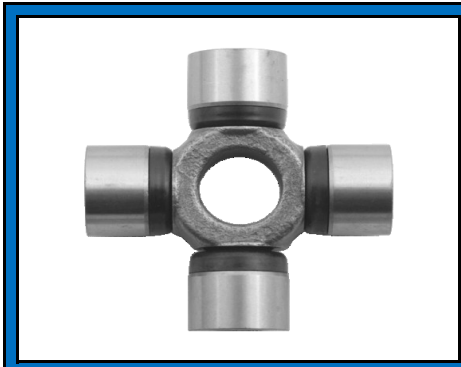

66500

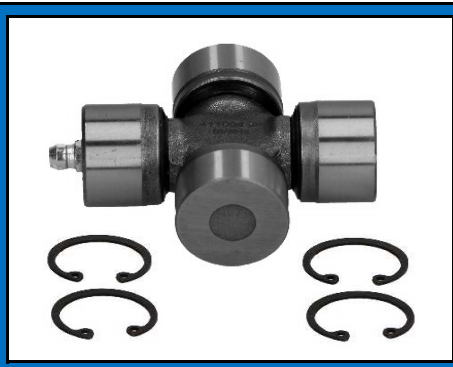

66501

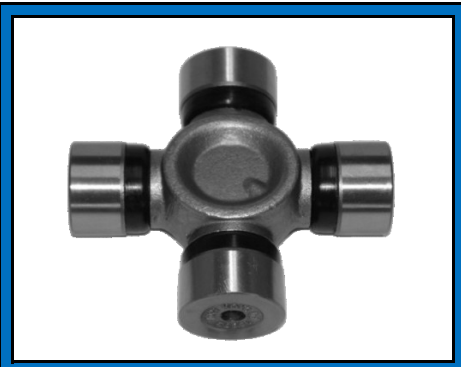

66502

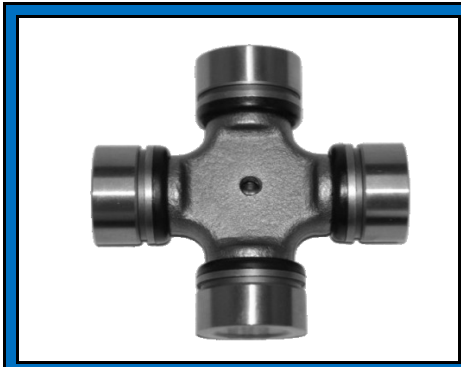

66503

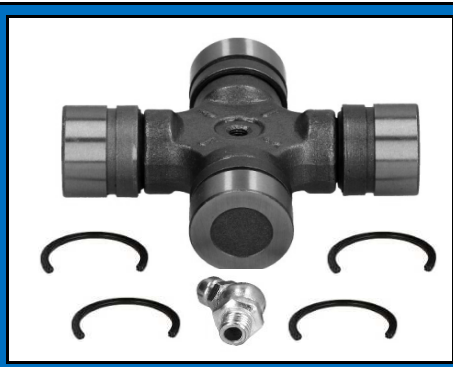

66505

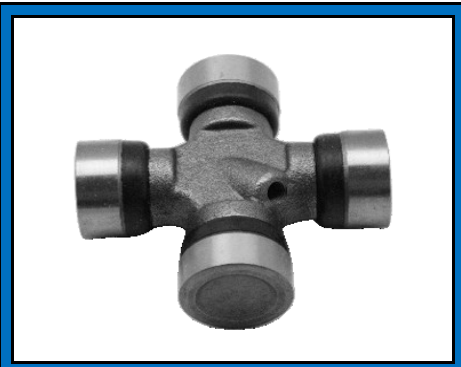

N.B.: I CODICI O.E. ED IL LORO TESTO SONO RIPORTATI SOLO A TITOLO INDICATIVO
 THE O.E. CODES AND THEIR TEXT ARE REPORTED ONLY FOR INDICATIVE PURPOSE

IMMAGINI - IMAGES

66506



66600



66601



66602

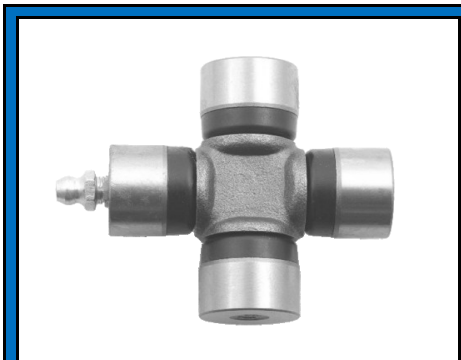

66800



66801

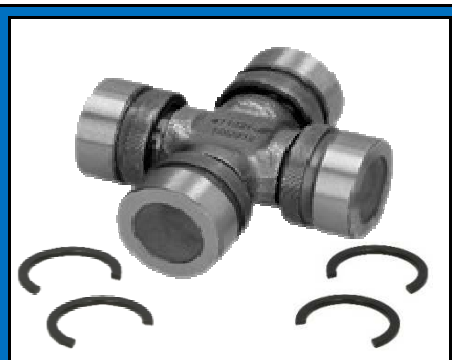

66802



66804



66805



66806



66901



66902



N.B.: I CODICI O.E. ED IL LORO TESTO SONO RIPORTATI SOLO A TITOLO INDICATIVO
 THE O.E. CODES AND THEIR TEXT ARE REPORTED ONLY FOR INDICATIVE PURPOSE

IMMAGINI - IMAGES

66904



66905



66906



66907



66908

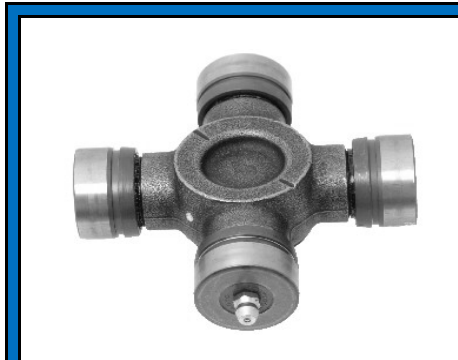

66912



66914



66916



66917



66H00



66H01



66H04



N.B.: I CODICI O.E. ED IL LORO TESTO SONO RIPORTATI SOLO A TITOLO INDICATIVO
 THE O.E. CODES AND THEIR TEXT ARE REPORTED ONLY FOR INDICATIVE PURPOSE

IMMAGINI - IMAGES

66H07

66K00

66K01



66K02

66L01

66L02



66L03

66W00

66W01

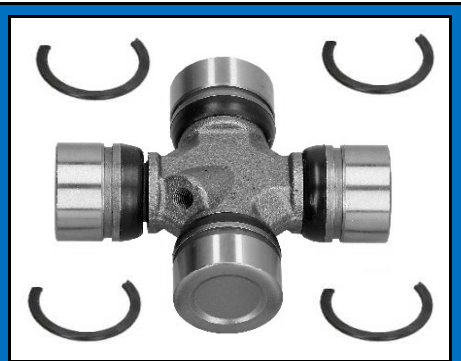
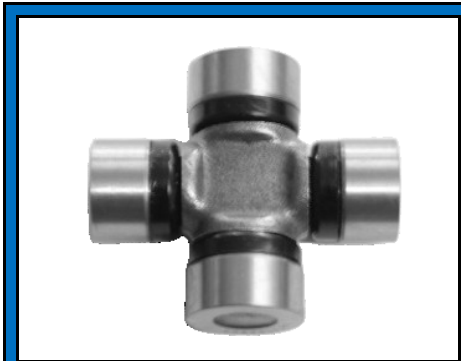

N.B.: I CODICI O.E. ED IL LORO TESTO SONO RIPORTATI SOLO A TITOLO INDICATIVO
 THE O.E. CODES AND THEIR TEXT ARE REPORTED ONLY FOR INDICATIVE PURPOSE

JAPANPARTS S.R.L.

Via della Meccanica, 1/A - 37139 - Verona (IT)

tel. +39 045 8517711 - fax + 39 045 8510714

info@japanparts.it

JapKo®



www.japko.it