



Company

Born over 35 years ago to distribute a complete and quality range of spare parts for Asian vehicles, Japanparts srl stands out today for an increasingly articulated offer covering European and American applications.



JAPANPARTS s.r.l.



Japanparts s.r.l. has been working since 1988 as a leading company in the import and distribution of spare parts for Asian, American and European vehicles.

The company offers a wide range with high quality standards, an efficient logistics, that few companies can boast and a widespread distribution in Italy and abroad.

Wide, deep and quality range

9 families, 158 (product) lines and 69.000 items make up **the complete range of spare parts** offered by Japanparts srl to cover the mechanical, electrical and reconditioning needs of European, Asian and American cars. The offer stands out for its breadth and for the careful selection of suppliers, always chosen on the basis of high-quality standards.

All-round player

The Japanparts srl offer is constantly updated to take into consideration the new needs of **the auto repair sector**, in terms of new products and codes. Japanparts srl presents itself today as an increasingly important company in the aftermarket, capable of competing, in terms of quality and supply, with the best international companies.

An enviable logistics

Each product distributed by Japanparts srl benefits from a timely customer service: **24 hours for the Italian peninsula, 48 hours for the islands** and a maximum of **5 days for abroad**.

All this is made possible by a warehouse with a **storage area** of over **70.000 square meters**, which guarantees the availability of spare parts in each moment.

A widespread distribution

Japanparts srl products are available in Italy thanks to agreements with over **50 distribution partners**.

Japanparts srl has a strong market breakthrough also abroad, with more than **400 partner companies** in the main geographical areas on a global level.

Our company has been certified ISO 9001:2015 for its advanced logistics, as evidence of the high efficiency achieved. All our processes follow strict protocols that ensure an excellent and timely service to all our customers.

Azienda

Nata oltre 35 anni fa per distribuire una gamma completa e di qualità di ricambi per veicoli asiatici, Japanparts srl si distingue oggi per un'offerta sempre più articolata a copertura di applicazioni europee e americane.

JAPANPARTS s.r.l.



Japanparts S.r.l. opera dal 1988 come azienda leader nel settore dell'importazione e distribuzione di ricambi per veicoli asiatici, americani ed europei.

L'azienda offre gamme ampie, pofonde e dagli elevati standard qualitativi. Una logistica efficiente che poche aziende possono vantare ed una distribuzione capillare in Italia e all'estero.

Gamme ampie, profonde e di qualità

9 famiglie, 158 linee e circa 69.000 codici prodotto compongono **la gamma completa di ricambi** offerti da Japanparts S.r.l. per coprire le esigenze meccaniche, elettriche e di rettifica di vetture europee, asiatiche e americane. L'offerta si distingue per ampiezza, profondità e per l'accurata selezione dei fornitori, scelti sempre in base agli elevati standard qualitativi.

Player a tutto tondo

L'offerta di Japanparts S.r.l. viene costantemente aggiornata per tener conto delle nuove esigenze del settore **della riparazione auto**, sia in termini di nuovi prodotti sia codici. Japanparts S.r.l. si presenta oggi come un'azienda sempre più importante dell'aftermarket, capace di competere, per qualità e offerta, con le migliori realtà internazionali.

Una logistica invidiabile

Ogni prodotto distribuito da Japanparts S.r.l. beneficia di un servizio al cliente tempestivo: **24 ore per la penisola, 48 ore per le isole e massimo 5 giorni per l'estero.**

Tutto ciò è reso possibile da un **magazzino** con una superficie di stoccaggio di oltre **70.000 mq.** che garantisce in ogni momento la disponibilità dei ricambi.

Una distribuzione capillare

I prodotti di Japanparts S.r.l. sono disponibili in Italia grazie ad accordi con oltre **50 partner distributivi.** Japanparts S.r.l. ha una forte penetrazione commerciale anche all'estero, con più di **400 aziende partner** nelle principali aree geografiche a livello globale.

La nostra azienda è stata certificata ISO 9001:2015 per la sua evoluta logistica, a testimonianza dell'elevata efficienza raggiunta. Tutti i nostri processi seguono rigidi protocolli che assicurano un servizio eccellente e tempestivo a tutta la nostra clientela.



JapKo[®]

APPLICAZIONE (APPLICATION)	ANNO (YEAR)	CODICE (CODE)	LATO (SIDE)	O.E. (OR. NUMBER)	LUNGH. (LENGTH)
A3 (8V1 - 8VK) A3 CABRIO (8V7 - 8VE)	05/13 > 10/20	BPW-312	ANTERIORE (FRONT)	8V0615437	170 mm.
A3 LIMOUSINE (8VS - 8VM) A3 LIMOUSINE (8YS - 8YM)	05/13 >	BPW-312	ANTERIORE (FRONT)	8V0615437	170 mm.
A3 SPORTBACK (8VA - 8VF)	05/13 > 10/20	BPW-312	ANTERIORE (FRONT)	8V0615437	170 mm.
A3 SPORTBACK (8YA - 8YF)	11/19 >	BPW-312	ANTERIORE (FRONT)	8V0615437	170 mm.
A4 (B8) A4 AVANT (B8)	01/08 > 12/15	BPW-006	ANTERIORE (FRONT)	8K0615121 4G0615121B	300 mm.
A4 (B8) A4 AVANT (B8)	01/08 > 12/15	BPW-300	POSTERIORE (REAR)	4G0615121	215 mm.
A4 (B9) A4 AVANT (B9)	08/15 >	BPW-031	ANTERIORE (FRONT)	4M0615121R 4M0615121S 4M0615121AB	400 mm.
A4 (B9) A4 AVANT (B9)	08/15 >	BPW-083	ANTERIORE (FRONT)	8W0615121H	280 mm.
A4 (B9) A4 AVANT (B9)	08/15 >	BPW-313	POSTERIORE (REAR)	8W0615121E	390 mm.
A5 (8T3)	06/07 > 01/17	BPW-006	ANTERIORE (FRONT)	8K0615121 4G0615121B	300 mm.
A5 (F53 - F5P) A5 CABRIO (F57 - F5E)	06/16 >	BPW-031	ANTERIORE (FRONT)	4M0615121R 4M0615121S 4M0615121AB	400 mm.
A5 (F53 - F5P) A5 CABRIO (F57 - F5E)	06/16 >	BPW-083	ANTERIORE (FRONT)	8W0615121H	280 mm.
A5 (F53 - F5P) A5 CABRIO (F57 - F5E)	06/16 >	BPW-313	POSTERIORE (REAR)	8W0615121E	390 mm.
A5 SPORTBACK (8TA)	09/09 > 01/17	BPW-006	ANTERIORE (FRONT)	8K0615121 4G0615121B	300 mm.
A5 SPORTBACK (F5A - F5F)	09/16 >	BPW-031	ANTERIORE (FRONT)	4M0615121R 4M0615121S 4M0615121AB	400 mm.
A5 SPORTBACK (F5A - F5F)	09/16 >	BPW-313	POSTERIORE (REAR)	8W0615121E	390 mm.

APPLICAZIONE (APPLICATION)	ANNO (YEAR)	CODICE (CODE)	LATO (SIDE)	O.E. (OR. NUMBER)	LUNGH. (LENGTH)
A6 (C7) A6 AVANT (C7)	11/10 > 09/18	BPW-006	ANTERIORE (FRONT)	8K0615121 4G0615121B	300 mm.
A6 (C7) A6 AVANT (C7)	11/10 > 09/18	BPW-051	ANTERIORE (FRONT)	4H0615121E 4H0615121F 4H0615121J	311 mm.
A6 (C7) A6 AVANT (C7)	11/10 > 09/18	BPW-098	ANTERIORE (FRONT)	8R0615121A 4G0615121C	361 mm.
A6 (C7) A6 AVANT (C7)	11/10 > 09/18	BPW-149	ANTERIORE (FRONT)	4H0615121 4H0615121P 4G0615121E	225 mm.
A6 (C7) A6 AVANT (C7)	11/10 > 09/18	BPW-185	POSTERIORE (REAR)	4H0615121B 4H0615121Q	450 mm.
A6 (C7) A6 AVANT (C7)	11/10 > 09/18	BPW-300	POSTERIORE (REAR)	4G0615121	215 mm.
A6 (C8) A6 AVANT (C8)	02/18 >	BPW-031	ANTERIORE (FRONT)	4M0615121R 4M0615121S 4M0615121AB	400 mm.
A6 (C8) A6 AVANT (C8)	02/18 >	BPW-083	ANTERIORE (FRONT)	8W0615121H	280 mm.
A6 (C8) A6 AVANT (C8)	02/18 >	BPW-185	POSTERIORE (REAR)	4H0615121B 4H0615121Q	450 mm.
A6 (C8) A6 AVANT (C8)	02/18 >	BPW-314	POSTERIORE (REAR)	80A615121	345 mm.
A7 SPORTBACK (4GA - 4GF)	10/10 > 05/18	BPW-006	ANTERIORE (FRONT)	8K0615121 4G0615121B	300 mm.
A7 SPORTBACK (4GA - 4GF)	10/10 > 05/18	BPW-098	ANTERIORE (FRONT)	8R0615121A 4G0615121C	361 mm.
A7 SPORTBACK (4GA - 4GF)	10/10 > 05/18	BPW-185	POSTERIORE (REAR)	4H0615121B 4H0615121Q	450 mm.
A7 SPORTBACK (4GA - 4GF)	10/10 > 05/18	BPW-300	POSTERIORE (REAR)	4G0615121	215 mm.
A7 SPORTBACK (4KA)	07/18 >	BPW-031	ANTERIORE (FRONT)	4M0615121R 4M0615121S 4M0615121AB	400 mm.
A7 SPORTBACK (4KA)	07/18 >	BPW-051	ANTERIORE (FRONT)	4H0615121E 4H0615121F 4H0615121J	311 mm.

APPLICAZIONE (APPLICATION)	ANNO (YEAR)	CODICE (CODE)	LATO (SIDE)	O.E. (OR. NUMBER)	LUNGH. (LENGHT)
A7 SPORTBACK (4KA)	07/18 >	BPW-083	ANTERIORE (FRONT)	8W0615121H	280 mm.
A7 SPORTBACK (4KA)	07/18 >	BPW-185	POSTERIORE (REAR)	4H0615121B 4H0615121Q	450 mm.
A7 SPORTBACK (4KA)	07/18 >	BPW-314	POSTERIORE (REAR)	80A615121	345 mm.
A8 (D4)	11/09 > 01/18	BPW-051	ANTERIORE (FRONT)	4H0615121E 4H0615121F 4H0615121J	311 mm.
A8 (D4)	11/09 > 01/18	BPW-149	ANTERIORE (FRONT)	4H0615121 4H0615121P 4G0615121E	225 mm.
A8 (D4)	11/09 > 01/18	BPW-185	POSTERIORE (REAR)	4H0615121B 4H0615121Q	450 mm.
A8 (D5)	06/17 >	BPW-031	ANTERIORE (FRONT)	4M0615121R 4M0615121S 4M0615121AB	400 mm.
A8 (D5)	06/17 >	BPW-041	POSTERIORE (REAR)	4M0615121P 8W0615121E	390 mm.
A8 (D5)	06/17 >	BPW-314	POSTERIORE (REAR)	80A615121	345 mm.
E-TRON (T.T.)	09/18 >	BPW-031	ANTERIORE (FRONT)	4M0615121R 4M0615121S 4M0615121AB	400 mm.
E-TRON (T.T.)	09/18 >	BPW-314	POSTERIORE (REAR)	80A615121	345 mm.
Q2 (GAB - GAG)	06/16 >	BPW-312	ANTERIORE (FRONT)	8V0615437	170 mm.
Q3 (F3B) Q3 SPORTBACK (F3N)	07/18 >	BPW-312	ANTERIORE (FRONT)	8V0615437	170 mm.
Q5 (8RB)	06/12 > 05/17	BPW-006	ANTERIORE (FRONT)	8K0615121 4G0615121B	300 mm.
Q5 (8RB)	06/12 > 05/17	BPW-051	ANTERIORE (FRONT)	4H0615121E 4H0615121F 4H0615121J	311 mm.
Q5 (8RB)	06/12 > 05/17	BPW-098	ANTERIORE (FRONT)	8R0615121A 4G0615121C	361 mm.

APPLICAZIONE (APPLICATION)	ANNO (YEAR)	CODICE (CODE)	LATO (SIDE)	O.E. (OR. NUMBER)	LUNGH. (LENGTH)
Q5 (FYB - FYG)	06/16 >	BPW-031	ANTERIORE (FRONT)	4M0615121R 4M0615121S 4M0615121AB	400 mm.
Q5 (FYB - FYG)	06/16 >	BPW-083	ANTERIORE (FRONT)	8W0615121H	280 mm.
Q5 (FYB - FYG)	06/16 >	BPW-169	ANTERIORE (FRONT)	80A615121A	290 mm.
Q5 (FYB - FYG)	06/16 >	BPW-314	POSTERIORE (REAR)	80A615121	345 mm.
Q5 SPORTBACK (FYT)	11/20 >	BPW-031	ANTERIORE (FRONT)	4M0615121R 4M0615121S 4M0615121AB	400 mm.
Q5 SPORTBACK (FYT)	11/20 >	BPW-083	ANTERIORE (FRONT)	8W0615121H	280 mm.
Q5 SPORTBACK (FYT)	11/20 >	BPW-169	ANTERIORE (FRONT)	80A615121A	290 mm.
Q5 SPORTBACK (FYT)	11/20 >	BPW-314	POSTERIORE (REAR)	80A615121	345 mm.
Q7 (4LB)	03/06 > 08/15	BPW-014	ANTERIORE (FRONT)	7L0907637 8J0615437	420 mm.
Q7 (4LB)	03/06 > 08/15	BPW-322	ANTERIORE (FRONT)	4L0615437	365 mm.
Q7 (4LB)	03/06 > 08/15	BPW-021	POSTERIORE (REAR)	7L0907637B 7L0907637C	255 mm.
Q7 (4LB)	03/06 > 08/15	BPW-321	POSTERIORE (REAR)	7L5907637B	245 mm.
Q7 (4LB)	03/06 > 08/15	BPW-323	POSTERIORE (REAR)	4L0615437A	275 mm.
Q7 (4MB - 4MG - 4MQ)	01/15 >	BPW-031	ANTERIORE (FRONT)	4M0615121R 4M0615121S 4M0615121AB	400 mm.
Q7 (4MB - 4MG - 4MQ)	01/15 >	BPW-041	POSTERIORE (REAR)	4M0615121P 8W0615121E	390 mm.
Q8 (4MN - 4MT)	02/18 >	BPW-031	ANTERIORE (FRONT)	4M0615121R 4M0615121S 4M0615121AB	400 mm.

N.B.: I CODICI O.E. ED IL LORO TESTO SONO RIPORTATI SOLO A TITOLO INDICATIVO
THE O.E. CODES AND THEIR TEXT ARE REPORTED ONLY FOR INDICATIVE PURPOSE

APPLICAZIONE (APPLICATION)	ANNO (YEAR)	CODICE (CODE)	LATO (SIDE)	O.E. (OR. NUMBER)	LUNGH. (LENGHT)
i3 (I01)	08/13 >	BPW-137	ANTERIORE (FRONT)	34356799329	679 mm.
i4 (G26)	11/21 >	BPW-298	ANTERIORE (FRONT)	34356870354	795 mm.
i4 (G26)	11/21 >	BPW-299	ANTERIORE (FRONT)	34356870349	760 mm.
IX (I20)	07/21 >	BPW-309	ANTERIORE (FRONT)	34356891369	880 mm.
SERIE 1 (E81 - E87)	09/06 > 12/11	BPW-037	ANTERIORE (FRONT)	34356762252 34356789439	640 mm.
SERIE 1 (E81 - E87)	09/06 > 12/11	BPW-045	ANTERIORE (FRONT)	34356777649 34356789440	690 mm.
SERIE 1 (E81 - E87)	09/06 > 12/11	BPW-076	ANTERIORE (FRONT)	34356792559	650 mm.
SERIE 1 (E81 - E87)	09/06 > 12/11	BPW-088	ANTERIORE (FRONT)	34356792560	723 mm.
SERIE 1 (E81 - E87)	09/06 > 12/11	BPW-028	POSTERIORE (REAR)	34356762253 34356789445	1098 mm.
SERIE 1 (E81 - E87)	09/06 > 12/11	BPW-063	POSTERIORE (REAR)	34356792564	1107 mm.
SERIE 1 CABRIO (E88) SERIE 1 COUPE' (E82)	12/07 > 12/13	BPW-037	ANTERIORE (FRONT)	34356762252 34356789439	640 mm.
SERIE 1 CABRIO (E88) SERIE 1 COUPE' (E82)	12/07 > 12/13	BPW-045	ANTERIORE (FRONT)	34356777649 34356789440	690 mm.
SERIE 1 CABRIO (E88) SERIE 1 COUPE' (E82)	12/07 > 12/13	BPW-076	ANTERIORE (FRONT)	34356792559	650 mm.
SERIE 1 CABRIO (E88) SERIE 1 COUPE' (E82)	12/07 > 12/13	BPW-088	ANTERIORE (FRONT)	34356792560	723 mm.
SERIE 1 CABRIO (E88) SERIE 1 COUPE' (E82)	12/07 > 12/13	BPW-028	POSTERIORE (REAR)	34356762253 34356789445	1098 mm.
SERIE 1 CABRIO (E88) SERIE 1 COUPE' (E82)	12/07 > 12/13	BPW-063	POSTERIORE (REAR)	34356792564	1107 mm.

APPLICAZIONE (APPLICATION)	ANNO (YEAR)	CODICE (CODE)	LATO (SIDE)	O.E. (OR. NUMBER)	LUNGH. (LENGHT)
SERIE 1 (F20 - F21)	07/11 > 12/19	BPW-008	ANTERIORE (FRONT)	34356792289	300 mm.
SERIE 1 (F20 - F21)	07/11 > 12/19	BPW-010	POSTERIORE (REAR)	34356792292	1045 mm.
SERIE 1 (F40)	07/19 >	BPW-015	ANTERIORE (FRONT)	34356888167 34356865613 34351543830	655 mm.
SERIE 1 (F40)	07/19 >	BPW-011	POSTERIORE (REAR)	34356865612 34356799736	655 mm.
SERIE 2 (F22 - F23)	03/14 > 06/21	BPW-008	ANTERIORE (FRONT)	34356792289	300 mm.
SERIE 2 (F22 - F23)	03/14 > 06/21	BPW-010	POSTERIORE (REAR)	34356792292	1045 mm.
SERIE 2 ACTIVE TOURER (F45)	11/13 > 10/21	BPW-015	ANTERIORE (FRONT)	34356888167 34356865613 34351543830	655 mm.
SERIE 2 ACTIVE TOURER (F45)	11/13 > 10/21	BPW-011	POSTERIORE (REAR)	34356865612 34356799736	655 mm.
SERIE 2 GRAN COUPE' (F44)	11/19 >	BPW-015	ANTERIORE (FRONT)	34356888167 34356865613 34351543830	655 mm.
SERIE 2 GRAN COUPE' (F44)	11/19 >	BPW-011	POSTERIORE (REAR)	34356865612 34356799736	655 mm.
SERIE 2 GRAN TOURER (F46)	08/14 >	BPW-015	ANTERIORE (FRONT)	34356888167 34356865613 34351543830	655 mm.
SERIE 2 GRAN TOURER (F46)	08/14 >	BPW-011	POSTERIORE (REAR)	34356865612 34356799736	655 mm.
SERIE 2 COUPE' (G42 - G87)	08/21 >	BPW-298	ANTERIORE (FRONT)	34356870354	795 mm.
SERIE 2 COUPE' (G42 - G87)	08/21 >	BPW-299	ANTERIORE (FRONT)	34356870349	760 mm.
SERIE 3 (E30) T.T. SERIE 3 TOURING (E30)	09/83 > 12/91	BPW-217	ANTERIORE (FRONT)	34351153964 34359058889	235 mm.
SERIE 3 (E30) T.T. SERIE 3 TOURING (E30)	09/83 > 12/91	BPW-119	POSTERIORE (REAR)	34111152607 34351180782 34351179819	262 mm.

APPLICAZIONE (APPLICATION)	ANNO (YEAR)	CODICE (CODE)	LATO (SIDE)	O.E. (OR. NUMBER)	LUNGH. (LENGHT)
SERIE 3 (E36) SERIE 3 TOURING (E36)	09/90 > 08/00	BPW-126	ANT. - POST. (FRONT - REAR)	34351181337 34351181338	776 mm.
SERIE 3 (E36) SERIE 3 TOURING (E36)	09/90 > 08/00	BPW-203	POSTERIORE (REAR)	34351181342 34351181344	790 mm.
SERIE 3 COMPACT (E36)	01/94 > 08/00	BPW-318	POSTERIORE (REAR)	34351182533	840 mm.
SERIE 3 (E46) T.T.	12/97 > 02/05	BPW-039	ANTERIORE (FRONT)	34351164371	596 mm.
SERIE 3 (E46) T.T.	12/97 > 02/05	BPW-131	ANTERIORE (FRONT)	34356751311	650 mm.
SERIE 3 (E46) T.T.	12/97 > 02/05	BPW-040	POSTERIORE (REAR)	34351164372 34352229780	1340 mm.
SERIE 3 (E90)	12/04 > 12/11	BPW-037	ANTERIORE (FRONT)	34356762252 34356789439	640 mm.
SERIE 3 (E90)	12/04 > 12/11	BPW-045	ANTERIORE (FRONT)	34356777649 34356789440	690 mm.
SERIE 3 (E90)	12/04 > 12/11	BPW-062	ANTERIORE (FRONT)	34356792561	867 mm.
SERIE 3 (E90)	12/04 > 12/11	BPW-076	ANTERIORE (FRONT)	34356792559	650 mm.
SERIE 3 (E90)	12/04 > 12/11	BPW-088	ANTERIORE (FRONT)	34356792560	723 mm.
SERIE 3 (E90)	12/04 > 12/11	BPW-128	ANTERIORE (FRONT)	34356764851 34356777650 34356789441	850 mm.
SERIE 3 (E90)	12/04 > 12/11	BPW-028	POSTERIORE (REAR)	34356762253 34356789445	1098 mm.
SERIE 3 (E90)	12/04 > 12/11	BPW-063	POSTERIORE (REAR)	34356792564	1107 mm.
SERIE 3 CABRIO (E93) SERIE 3 COUPE' (E92)	03/06 > 12/13	BPW-037	ANTERIORE (FRONT)	34356762252 34356789439	640 mm.
SERIE 3 CABRIO (E93) SERIE 3 COUPE' (E92)	03/06 > 12/13	BPW-045	ANTERIORE (FRONT)	34356777649 34356789440	690 mm.

APPLICAZIONE (APPLICATION)	ANNO (YEAR)	CODICE (CODE)	LATO (SIDE)	O.E. (OR. NUMBER)	LUNGH. (LENGHT)
SERIE 3 CABRIO (E93) SERIE 3 COUPE' (E92)	03/06 > 12/13	BPW-062	ANTERIORE (FRONT)	34356792561	867 mm.
SERIE 3 CABRIO (E93) SERIE 3 COUPE' (E92)	03/06 > 12/13	BPW-076	ANTERIORE (FRONT)	34356792559	650 mm.
SERIE 3 CABRIO (E93) SERIE 3 COUPE' (E92)	03/06 > 12/13	BPW-088	ANTERIORE (FRONT)	34356792560	723 mm.
SERIE 3 CABRIO (E93) SERIE 3 COUPE' (E92)	03/06 > 12/13	BPW-128	ANTERIORE (FRONT)	34356764851 34356777650 34356789441	850 mm.
SERIE 3 CABRIO (E93) SERIE 3 COUPE' (E92)	03/06 > 12/13	BPW-028	POSTERIORE (REAR)	34356762253 34356789445	1098 mm.
SERIE 3 CABRIO (E93) SERIE 3 COUPE' (E92)	03/06 > 12/13	BPW-063	POSTERIORE (REAR)	34356792564	1107 mm.
SERIE 3 TOURING (E91)	12/04 > 12/12	BPW-037	ANTERIORE (FRONT)	34356762252 34356789439	640 mm.
SERIE 3 TOURING (E91)	12/04 > 12/12	BPW-045	ANTERIORE (FRONT)	34356777649 34356789440	690 mm.
SERIE 3 TOURING (E91)	12/04 > 12/12	BPW-062	ANTERIORE (FRONT)	34356792561	867 mm.
SERIE 3 TOURING (E91)	12/04 > 12/12	BPW-076	ANTERIORE (FRONT)	34356792559	650 mm.
SERIE 3 TOURING (E91)	12/04 > 12/12	BPW-088	ANTERIORE (FRONT)	34356792560	723 mm.
SERIE 3 TOURING (E91)	12/04 > 12/12	BPW-128	ANTERIORE (FRONT)	34356764851 34356777650 34356789441	850 mm.
SERIE 3 TOURING (E91)	12/04 > 12/12	BPW-028	POSTERIORE (REAR)	34356762253 34356789445	1098 mm.
SERIE 3 TOURING (E91)	12/04 > 12/12	BPW-063	POSTERIORE (REAR)	34356792564	1107 mm.
SERIE 3 (G20 - G28 - G80) SERIE 3 TOURING (G21 - G81)	11/18 >	BPW-298	ANTERIORE (FRONT)	34356870354	795 mm.
SERIE 3 (G20 - G28 - G80) SERIE 3 TOURING (G21 - G81)	11/18 >	BPW-299	ANTERIORE (FRONT)	34356870349	760 mm.

APPLICAZIONE (APPLICATION)	ANNO (YEAR)	CODICE (CODE)	LATO (SIDE)	O.E. (OR. NUMBER)	LUNGH. (LENGTH)
SERIE 4 COUPE' (G22 - G26 - G82) SERIE 4 CABRIO (G23 - G83)	07/20 >	BPW-299	ANTERIORE (FRONT)	34356870349	760 mm.
SERIE 5 (E28)	01/85 > 12/87	BPW-330	ANTERIORE (FRONT)	34212225229 34351179821	164 mm.
SERIE 5 (E28)	01/85 > 12/87	BPW-119	POSTERIORE (REAR)	34111152607 34351180782 34351179819	262 mm.
SERIE 5 (E34) SERIE 5 TOURING (E34)	06/87 > 12/95	BPW-178	ANTERIORE (FRONT)	34112225107 34351179820 34351180432	230 mm.
SERIE 5 (E39) SERIE 5 TOURING (E39)	09/95 > 05/04	BPW-085	ANTERIORE (FRONT)	34351163065 34352229018	830 mm.
SERIE 5 (E39) SERIE 5 TOURING (E39)	09/95 > 05/04	BPW-111	POSTERIORE (REAR)	34351163066	545 mm.
SERIE 5 TOURING (E39)	03/97 > 05/04	BPW-206	POSTERIORE (REAR)	34351163207	1100 mm.
SERIE 5 TOURING (E61)	03/04 > 12/10	BPW-117	POSTERIORE (REAR)	34356763667 34356776423 34356789494	883 mm.
SERIE 5 (F10)	06/09 > 10/16	BPW-013	ANTERIORE (FRONT)	34356791958	1087 mm.
SERIE 5 (F10)	06/09 > 10/16	BPW-016	POSTERIORE (REAR)	34356791962	915 mm.
SERIE 5 GRAN TURISMO (F07)	04/11 > 12/17	BPW-013	ANTERIORE (FRONT)	34356791958	1087 mm.
SERIE 5 GRAN TURISMO (F07)	04/11 > 12/17	BPW-108	POSTERIORE (REAR)	34356791961	1055 mm.
SERIE 5 TOURING (F11)	11/09 > 02/17	BPW-013	ANTERIORE (FRONT)	34356791958	1087 mm.
SERIE 5 TOURING (F11)	11/09 > 02/17	BPW-114	POSTERIORE (REAR)	34356791963	1110 mm.
SERIE 5 (G30 - F90)	09/16 > 06/23	BPW-022	ANTERIORE (FRONT)	34356861807 34356890788	920 mm.
SERIE 5 (G30 - F90)	09/16 > 06/23	BPW-026	POSTERIORE (REAR)	34356861808 34356890791	925 mm.

APPLICAZIONE (APPLICATION)	ANNO (YEAR)	CODICE (CODE)	LATO (SIDE)	O.E. (OR. NUMBER)	LUNGH. (LENGHT)
SERIE 5 (G30 - F90)	09/16 > 06/23	BPW-124	POSTERIORE (REAR)	34216890792 34216861809	850 mm.
SERIE 5 TOURING (G31)	07/17 >	BPW-022	ANTERIORE (FRONT)	34356861807 34356890788	920 mm.
SERIE 5 TOURING (G31)	07/17 >	BPW-026	POSTERIORE (REAR)	34356861808 34356890791	925 mm.
SERIE 5 TOURING (G31)	07/17 >	BPW-124	POSTERIORE (REAR)	34216890792 34216861809	850 mm.
SERIE 6 (E24)	09/79 > 08/87	BPW-330	ANTERIORE (FRONT)	34212225229 34351179821	164 mm.
SERIE 6 (E24)	09/79 > 08/87	BPW-119	POSTERIORE (REAR)	34111152607 34351180782 34351179819	262 mm.
SERIE 6 (E63) SERIE 6 CABRIO (E64)	09/03 > 08/10	BPW-043	ANTERIORE (FRONT)	34356764298 34356776421 34356789492	670 mm.
SERIE 6 (E63) SERIE 6 CABRIO (E64)	09/03 > 08/10	BPW-055	POSTERIORE (REAR)	34356764299 34356776422 34356789493	670 mm.
SERIE 6 CABRIO (F12)	09/11 > 06/18	BPW-013	ANTERIORE (FRONT)	34356791958	1087 mm.
SERIE 6 CABRIO (F12)	09/11 > 06/18	BPW-016	POSTERIORE (REAR)	34356791962	915 mm.
SERIE 6 COUPE' (F13) SERIE 6 GRAN COUPE' (F06)	09/11 > 10/18	BPW-013	ANTERIORE (FRONT)	34356791958	1087 mm.
SERIE 6 COUPE' (F13) SERIE 6 GRAN COUPE' (F06)	09/11 > 10/18	BPW-016	POSTERIORE (REAR)	34356791962	915 mm.
SERIE 6 GRAN TURISMO (G32)	06/17 >	BPW-022	ANTERIORE (FRONT)	34356861807 34356890788	920 mm.
SERIE 6 GRAN TURISMO (G32)	06/17 >	BPW-124	POSTERIORE (REAR)	34216890792 34216861809	850 mm.
SERIE 7 (E23)	05/77 > 08/86	BPW-330	ANTERIORE (FRONT)	34212225229 34351179821	164 mm.
SERIE 7 (E32)	03/87 > 09/94	BPW-178	ANTERIORE (FRONT)	34112225107 34351179820 34351180432	230 mm.

APPLICAZIONE (APPLICATION)	ANNO (YEAR)	CODICE (CODE)	LATO (SIDE)	O.E. (OR. NUMBER)	LUNGH. (LENGHT)
SERIE 7 (E38)	03/94 > 11/01	BPW-191	POSTERIORE (REAR)	34351182065	620 mm.
SERIE 7 (E65 - E66 - E67)	07/01 > 08/08	BPW-112	ANTERIORE (FRONT)	34356755266 34356778037	830 mm.
SERIE 7 (E65 - E66 - E67)	07/01 > 08/08	BPW-113	POSTERIORE (REAR)	34356755267 34356778038	845 mm.
SERIE 7 (F01 - F02 - F03 - F04)	09/08 > 12/15	BPW-013	ANTERIORE (FRONT)	34356791958	1087 mm.
SERIE 7 (F01 - F02 - F03 - F04)	09/08 > 12/15	BPW-331	ANTERIORE (FRONT)	34356775850	1055 mm.
SERIE 7 (F01 - F02 - F03 - F04)	09/08 > 12/15	BPW-082	POSTERIORE (REAR)	34356791960	1065 mm.
SERIE 7 (G11 - G12)	09/15 > 06/22	BPW-022	ANTERIORE (FRONT)	34356861807 34356890788	920 mm.
SERIE 7 (G11 - G12)	09/15 > 06/22	BPW-026	POSTERIORE (REAR)	34356861808 34356890791	925 mm.
SERIE 8 (E31)	01/90 > 08/94	BPW-178	ANTERIORE (FRONT)	34112225107 34351179820 34351180432	230 mm.
SERIE 8 CABRIO (G14 - F91)	07/18 >	BPW-022	ANTERIORE (FRONT)	34356861807 34356890788	920 mm.
SERIE 8 CABRIO (G14 - F91)	07/18 >	BPW-026	POSTERIORE (REAR)	34356861808 34356890791	925 mm.
SERIE 8 COUPE' (G15 - F92) SERIE 8 GRAN COUPE' (G16 - F93)	07/18 >	BPW-022	ANTERIORE (FRONT)	34356861807 34356890788	920 mm.
SERIE 8 COUPE' (G15 - F92) SERIE 8 GRAN COUPE' (G16 - F93)	07/18 >	BPW-026	POSTERIORE (REAR)	34356861808 34356890791	925 mm.
X1 (E84)	09/09 > 06/15	BPW-062	ANTERIORE (FRONT)	34356792561	867 mm.
X1 (E84)	09/09 > 06/15	BPW-079	ANTERIORE (FRONT)	34356792562	676 mm.
X1 (E84)	09/09 > 06/15	BPW-128	ANTERIORE (FRONT)	34356764851 34356777650 34356789441	850 mm.

APPLICAZIONE (APPLICATION)	ANNO (YEAR)	CODICE (CODE)	LATO (SIDE)	O.E. (OR. NUMBER)	LUNGH. (LENGHT)
X1 (E84)	09/09 > 06/15	BPW-205	ANTERIORE (FRONT)	34356790340	632 mm.
X1 (E84)	09/09 > 06/15	BPW-056	POSTERIORE (REAR)	34356792565	1141 mm.
X1 (E84)	09/09 > 06/15	BPW-144	POSTERIORE (REAR)	34356790341	1120 mm.
X1 (F48)	11/14 > 06/22	BPW-015	ANTERIORE (FRONT)	34356888167 34356865613 34351543830	655 mm.
X1 (F48)	11/14 > 06/22	BPW-011	POSTERIORE (REAR)	34356865612 34356799736	655 mm.
X2 (F39)	11/17 > 10/23	BPW-015	ANTERIORE (FRONT)	34356888167 34356865613 34351543830	655 mm.
X2 (F39)	11/17 > 10/23	BPW-011	POSTERIORE (REAR)	34356865612 34356799736	655 mm.
X3 (E83)	01/04 > 08/10	BPW-081	ANTERIORE (FRONT)	34353411756	740 mm.
X3 (E83)	01/04 > 08/10	BPW-084	POSTERIORE (REAR)	34353411757	1055 mm.
X3 (F25)	09/10 > 08/17	BPW-029	ANTERIORE (FRONT)	34356790303	955 mm.
X3 (F25)	09/10 > 08/17	BPW-030	POSTERIORE (REAR)	34356790304	1234 mm.
X3 (G01 - F97 - G08)	08/17 >	BPW-049	ANTERIORE (FRONT)	34356870351	770 mm.
X3 (G01 - F97 - G08)	08/17 >	BPW-053	POSTERIORE (REAR)	34356870350	740 mm.
X4 (F26)	04/14 > 03/18	BPW-029	ANTERIORE (FRONT)	34356790303	955 mm.
X4 (F26)	04/14 > 03/18	BPW-030	POSTERIORE (REAR)	34356790304	1234 mm.
X4 (G02 - F98)	04/18 >	BPW-049	ANTERIORE (FRONT)	34356870351	770 mm.

N.B.: I CODICI O.E. ED IL LORO TESTO SONO RIPORTATI SOLO A TITOLO INDICATIVO
THE O.E. CODES AND THEIR TEXT ARE REPORTED ONLY FOR INDICATIVE PURPOSE

APPLICAZIONE (APPLICATION)	ANNO (YEAR)	CODICE (CODE)	LATO (SIDE)	O.E. (OR. NUMBER)	LUNGH. (LENGHT)
X4 (G02 - F98)	04/18 >	BPW-053	POSTERIORE (REAR)	34356870350	740 mm.
X4 (G02 - F98)	04/18 >	BPW-102	POSTERIORE (REAR)	34356880543	750 mm.
X5 (E53)	04/00 > 10/06	BPW-078	ANTERIORE (FRONT)	34351165579	800 mm.
X5 (E53)	04/00 > 10/06	BPW-071	POSTERIORE (REAR)	34351165580	715 mm.
X5 (E70)	10/08 > 07/13	BPW-038	ANTERIORE (FRONT)	34356792567	895 mm.
X5 (E70)	10/08 > 07/13	BPW-060	ANTERIORE (FRONT)	34356772008 34356789501	970 mm.
X5 (E70)	10/08 > 07/13	BPW-158	ANTERIORE (FRONT)	34356773008 34356789502	960 mm.
X5 (E70)	10/08 > 07/13	BPW-044	POSTERIORE (REAR)	34356792571 34356854168	1050 mm.
X5 (E70)	10/08 > 07/13	BPW-058	POSTERIORE (REAR)	34356771766 34356780699 34356789505	1006 mm.
X5 (F15 - F85)	12/13 > 07/18	BPW-038	ANTERIORE (FRONT)	34356792567	895 mm.
X5 (F15 - F85)	12/13 > 07/18	BPW-134	ANTERIORE (FRONT)	34356792568	1020 mm.
X5 (F15 - F85)	12/13 > 07/18	BPW-044	POSTERIORE (REAR)	34356792571 34356854168	1050 mm.
X5 (G05 - F95)	08/18 > 03/23	BPW-057	ANTERIORE (FRONT)	34356870353	850 mm.
X5 (G05 - F95)	08/18 > 03/23	BPW-074	POSTERIORE (REAR)	34356870352	755 mm.
X6 (E71 - E72)	01/08 > 07/14	BPW-038	ANTERIORE (FRONT)	34356792567	895 mm.
X6 (E71 - E72)	01/08 > 07/14	BPW-060	ANTERIORE (FRONT)	34356772008 34356789501	970 mm.

APPLICAZIONE (APPLICATION)	ANNO (YEAR)	CODICE (CODE)	LATO (SIDE)	O.E. (OR. NUMBER)	LUNGH. (LENGHT)
X6 (E71 - E72)	01/08 > 07/14	BPW-134	ANTERIORE (FRONT)	34356792568	1020 mm.
X6 (E71 - E72)	01/08 > 07/14	BPW-158	ANTERIORE (FRONT)	34356773008 34356789502	960 mm.
X6 (E71 - E72)	01/08 > 07/14	BPW-044	POSTERIORE (REAR)	34356792571 34356854168	1050 mm.
X6 (E71 - E72)	01/08 > 07/14	BPW-058	POSTERIORE (REAR)	34356771766 34356780699 34356789505	1006 mm.
X6 (F16 - F86)	08/14 > 07/19	BPW-038	ANTERIORE (FRONT)	34356792567	895 mm.
X6 (F16 - F86)	08/14 > 07/19	BPW-134	ANTERIORE (FRONT)	34356792568	1020 mm.
X6 (F16 - F86)	08/14 > 07/19	BPW-044	POSTERIORE (REAR)	34356792571 34356854168	1050 mm.
X6 (G06 - F96)	08/19 > 03/23	BPW-057	ANTERIORE (FRONT)	34356870353	850 mm.
X6 (G06 - F96)	08/19 > 03/23	BPW-074	POSTERIORE (REAR)	34356870352	755 mm.
X7 (G07)	03/19 >	BPW-057	ANTERIORE (FRONT)	34356870353	850 mm.
X7 (G07)	03/19 >	BPW-074	POSTERIORE (REAR)	34356870352	755 mm.
Z1 ROADSTER	06/88 > 06/91	BPW-217	ANTERIORE (FRONT)	34351153964 34359058889	235 mm.
Z1 ROADSTER	06/88 > 06/91	BPW-119	POSTERIORE (REAR)	34111152607 34351180782 34351179819	262 mm.
Z3 (E36) T.T.	10/95 > 06/03	BPW-126	ANTERIORE (FRONT)	34351181337 34351181338	776 mm.
Z3 (E36) T.T.	01/94 > 08/00	BPW-318	POSTERIORE (REAR)	34351182533	840 mm.
Z4 ROADSTER (E85)	12/02 > 02/09	BPW-039	ANTERIORE (FRONT)	34351164371	596 mm.

APPLICAZIONE (APPLICATION)	ANNO (YEAR)	CODICE (CODE)	LATO (SIDE)	O.E. (OR. NUMBER)	LUNGH. (LENGHT)
Z4 ROADSTER (E86) Z4 COUPE' (E86)	04/06 > 08/08	BPW-227	POSTERIORE (REAR)	34356757896	1220 mm.
Z4 ROADSTER (E89)	02/09 > 08/16	BPW-198	ANTERIORE (FRONT)	34356792563	1015 mm.
Z4 ROADSTER (E89)	02/09 > 08/16	BPW-181	POSTERIORE (REAR)	34356792566	1361 mm.
Z4 ROADSTER (E89)	02/09 > 08/16	BPW-232	POSTERIORE (REAR)	34356789446	1338 mm.
Z4 ROADSTER (G29)	11/18 >	BPW-138	ANTERIORE (FRONT)	34356877085	710 mm.
Z4 ROADSTER (G29)	11/18 >	BPW-298	ANTERIORE (FRONT)	34356870354	795 mm.
Z8 ROADSTER (E52)	01/00 > 12/03	BPW-111	POSTERIORE (REAR)	34351163066	545 mm.

N.B.: I CODICI O.E. ED IL LORO TESTO SONO RIPORTATI SOLO A TITOLO INDICATIVO
THE O.E. CODES AND THEIR TEXT ARE REPORTED ONLY FOR INDICATIVE PURPOSE

APPLICAZIONE (APPLICATION)	ANNO (YEAR)	CODICE (CODE)	LATO (SIDE)	O.E. (OR. NUMBER)	LUNGH. (LENGHT)
TOURNEO CUSTOM (V362)	09/12 > 12/23	BPW-315	ANTERIORE (FRONT)	1781726 1843310 2019275	315 mm.
TOURNEO CUSTOM (V362)	09/12 > 12/23	BPW-287	POSTERIORE (REAR)	1792658	475 mm.
TRANSIT (V363)	03/16 >	BPW-315	ANTERIORE (FRONT)	1781726 1843310 2019275	315 mm.
TRANSIT (V363)	03/16 >	BPW-291	POSTERIORE (REAR)	1843313 2183428	670 mm.
TRANSIT (V363)	03/16 >	BPW-297	POSTERIORE (REAR)	1829401 2030369	530 mm.
TRANSIT COURIER (V769)	11/23 >	BPW-334	POSTERIORE (REAR)	2686627 2686641	280 mm.

APPLICAZIONE (APPLICATION)	ANNO (YEAR)	CODICE (CODE)	LATO (SIDE)	O.E. (OR. NUMBER)	LUNGH. (LENGHT)
DAILY II	01/89 > 05/99	BPW-288	ANTERIORE (FRONT)	42548208 42567357 500054528	300 mm.
DAILY II	01/89 > 05/99	BPW-294	ANTERIORE (FRONT)	1908825 1907942	495 mm.
DAILY III	05/99 > 07/07	BPW-288	ANTERIORE (FRONT)	42548208 42567357 500054528	300 mm.
DAILY III	09/04 > 04/06	BPW-289	ANTERIORE (FRONT)	42548195 42560913 500054692	210 mm.
DAILY III	05/99 > 07/07	BPW-290	POSTERIORE (REAR)	42548196 42559616 500054696	250 mm.
DAILY IV	05/06 > 08/11	BPW-285	ANT. - POST. (FRONT - REAR)	42555634 42560068 42567356	130 mm.
DAILY IV	05/06 > 08/11	BPW-286	POSTERIORE (REAR)	42548209 42556205 500054695	295 mm.
DAILY IV	05/06 > 08/11	BPW-311	POSTERIORE (REAR)	42548209 42556205 500054695	295 mm.
DAILY IV	05/06 > 08/11	BPW-290	POSTERIORE (REAR)	42548196 42559616 500054696	250 mm.
DAILY V	09/11 > 02/14	BPW-285	ANT. - POST. (FRONT - REAR)	42555634 42560068 42567356	130 mm.
DAILY V	09/11 > 02/14	BPW-311	POSTERIORE (REAR)	42548209 42556205 500054695	295 mm.
DAILY VI	04/16 >	BPW-311	POSTERIORE (REAR)	42548209 42556205 500054695	295 mm.

APPLICAZIONE (APPLICATION)	ANNO (YEAR)	CODICE (CODE)	LATO (SIDE)	O.E. (OR. NUMBER)	LUNGH. (LENGHT)
E-PACE (X540)	09/17 >	BPW-100	ANTERIORE (FRONT)	J9C2212	1145 mm.
E-PACE (X540)	09/17 >	BPW-105	ANTERIORE (FRONT)	J9C18499	1040 mm.
E-PACE (X540)	09/17 >	BPW-139	ANTERIORE (FRONT)	J9C2211	1115 mm.
E-PACE (X540)	09/17 >	BPW-165	ANTERIORE (FRONT)	J9C18500	1035 mm.
E-PACE (X540)	09/17 >	BPW-091	POSTERIORE (REAR)	J9C2076	940 mm.
F-PACE (X761)	09/15 >	BPW-130	POSTERIORE (REAR)	T4A3216	1015 mm.
F-TYPE CABRIO (X152)	10/12 >	BPW-305	ANTERIORE (FRONT)	C2P17004	590 mm.
I-PACE (X590)	02/18 >	BPW-308	POSTERIORE (REAR)	T4K4054	955 mm.
XE (X760)	03/15 >	BPW-073	POSTERIORE (REAR)	T2H2091	935 mm.
XF I (X250)	03/08 > 04/15	BPW-179	ANTERIORE (FRONT)	C2Z16061	610 mm.
XF I (X250)	03/08 > 04/15	BPW-305	ANTERIORE (FRONT)	C2P17004	590 mm.
XF II (X260)	05/15 >	BPW-073	POSTERIORE (REAR)	T2H2091	935 mm.
XF SPORTBRAKE (X250)	09/12 > 04/14	BPW-179	ANTERIORE (FRONT)	C2Z16061	610 mm.
XF SPORTBRAKE (X250)	09/12 > 04/14	BPW-305	ANTERIORE (FRONT)	C2P17004	590 mm.
XF SPORTBRAKE (X260)	07/17 >	BPW-073	POSTERIORE (REAR)	T2H2091	935 mm.
XJ (X351)	10/09 > 12/19	BPW-305	ANTERIORE (FRONT)	C2P17004	590 mm.

N.B.: I CODICI O.E. ED IL LORO TESTO SONO RIPORTATI SOLO A TITOLO INDICATIVO
THE O.E. CODES AND THEIR TEXT ARE REPORTED ONLY FOR INDICATIVE PURPOSE

APPLICAZIONE (APPLICATION)	ANNO (YEAR)	CODICE (CODE)	LATO (SIDE)	O.E. (OR. NUMBER)	LUNGH. (LENGHT)
DEFENDER S.W. (L663)	09/19 >	BPW-095	ANTERIORE (FRONT)	LR084048 LR122455	1295 mm.
DEFENDER S.W. (L663)	09/19 >	BPW-106	ANTERIORE (FRONT)	LR098988	1285 mm.
DEFENDER S.W. (L663)	09/19 >	BPW-087	POSTERIORE (REAR)	LR084071	940 mm.
DISCOVERY III (L319)	07/04 > 09/09	BPW-143	ANTERIORE (FRONT)	SEM500070	1184 mm.
DISCOVERY III (L319)	07/04 > 09/09	BPW-047	POSTERIORE (REAR)	SOE000024 SOE000025	1183 mm.
DISCOVERY IV (L319)	09/09 > 12/18	BPW-143	ANTERIORE (FRONT)	SEM500070	1184 mm.
DISCOVERY IV (L319)	09/09 > 12/18	BPW-047	POSTERIORE (REAR)	SOE000024 SOE000025	1183 mm.
DISCOVERY V (L462)	09/16 >	BPW-035	ANTERIORE (FRONT)	LR045959	1370 mm.
DISCOVERY V (L462)	09/16 >	BPW-095	ANTERIORE (FRONT)	LR084048 LR122455	1295 mm.
DISCOVERY V (L462)	09/16 >	BPW-106	ANTERIORE (FRONT)	LR098988	1285 mm.
DISCOVERY V (L462)	09/16 >	BPW-032	POSTERIORE (REAR)	LR033295	951 mm.
DISCOVERY V (L462)	09/16 >	BPW-087	POSTERIORE (REAR)	LR084071	940 mm.
DISCOVERY SPORT (L550)	09/14 >	BPW-050	ANTERIORE (FRONT)	LR061365 LR121267	1170 mm.
DISCOVERY SPORT (L550)	09/14 >	BPW-105	ANTERIORE (FRONT)	LR115018	1040 mm.
DISCOVERY SPORT (L550)	09/14 >	BPW-135	ANTERIORE (FRONT)	LR083646	1185 mm.
DISCOVERY SPORT (L550)	09/14 >	BPW-070	POSTERIORE (REAR)	LR061394 LR072544	857 mm.

N.B.: I CODICI O.E. ED IL LORO TESTO SONO RIPORTATI SOLO A TITOLO INDICATIVO
THE O.E. CODES AND THEIR TEXT ARE REPORTED ONLY FOR INDICATIVE PURPOSE

APPLICAZIONE (APPLICATION)	ANNO (YEAR)	CODICE (CODE)	LATO (SIDE)	O.E. (OR. NUMBER)	LUNGH. (LENGHT)
DISCOVERY SPORT (L550)	09/14 >	BPW-091	POSTERIORE (REAR)	J9C2076	940 mm.
RANGE ROVER III (L322)	03/02 > 08/12	BPW-132	ANTERIORE (FRONT)	SEM000010 SEM000011 SEM000012	780 mm.
RANGE ROVER III (L322)	03/02 > 08/12	BPW-109	POSTERIORE (REAR)	SOE500030	1158 mm.
RANGE ROVER III (L322)	03/02 > 08/12	BPW-204	POSTERIORE (REAR)	SOE000010 SOE000011	1120 mm.
RANGE ROVER IV (L405)	08/12 > 09/21	BPW-035	ANTERIORE (FRONT)	LR045959	1370 mm.
RANGE ROVER IV (L405)	08/12 > 09/21	BPW-080	ANTERIORE (FRONT)	LR033275	1424 mm.
RANGE ROVER IV (L405)	08/12 > 09/21	BPW-095	ANTERIORE (FRONT)	LR084048 LR122455	1295 mm.
RANGE ROVER IV (L405)	08/12 > 09/21	BPW-106	ANTERIORE (FRONT)	LR098988	1285 mm.
RANGE ROVER IV (L405)	08/12 > 09/21	BPW-032	POSTERIORE (REAR)	LR033295	951 mm.
RANGE ROVER IV (L405)	10/17 > 09/21	BPW-087	POSTERIORE (REAR)	LR084071	940 mm.
RANGE ROVER V (L460)	10/21 >	BPW-304	ANTERIORE (FRONT)	LR153546	550 mm.
RANGE ROVER EVOQUE (L538)	05/11 > 12/19	BPW-050	ANTERIORE (FRONT)	LR061365 LR121267	1170 mm.
RANGE ROVER EVOQUE (L538)	05/11 > 12/19	BPW-135	ANTERIORE (FRONT)	LR083646	1185 mm.
RANGE ROVER EVOQUE (L551)	12/18 >	BPW-105	ANTERIORE (FRONT)	LR115018	1040 mm.
RANGE ROVER EVOQUE (L551)	12/18 >	BPW-165	ANTERIORE (FRONT)	LR115019	1035 mm.
RANGE ROVER EVOQUE (L551)	12/18 >	BPW-091	POSTERIORE (REAR)	J9C2076	940 mm.

N.B.: I CODICI O.E. ED IL LORO TESTO SONO RIPORTATI SOLO A TITOLO INDICATIVO
THE O.E. CODES AND THEIR TEXT ARE REPORTED ONLY FOR INDICATIVE PURPOSE

APPLICAZIONE (APPLICATION)	ANNO (YEAR)	CODICE (CODE)	LATO (SIDE)	O.E. (OR. NUMBER)	LUNGH. (LENGHT)
RANGE ROVER SPORT I (L320)	02/05 > 03/13	BPW-099	ANTERIORE (FRONT)	SEM500062	1230 mm.
RANGE ROVER SPORT I (L320)	02/05 > 03/13	BPW-186	ANTERIORE (FRONT)	SEM500026 SEM500090	1209 mm.
RANGE ROVER SPORT I (L320)	02/05 > 03/13	BPW-047	POSTERIORE (REAR)	SOE000024 SOE000025	1183 mm.
RANGE ROVER SPORT II (L494)	04/13 > 03/22	BPW-035	ANTERIORE (FRONT)	LR045959	1370 mm.
RANGE ROVER SPORT II (L494)	04/13 > 03/22	BPW-080	ANTERIORE (FRONT)	LR033275	1424 mm.
RANGE ROVER SPORT II (L494)	04/13 > 03/22	BPW-095	ANTERIORE (FRONT)	LR084048 LR122455	1295 mm.
RANGE ROVER SPORT II (L494)	04/13 > 03/22	BPW-106	ANTERIORE (FRONT)	LR098988	1285 mm.
RANGE ROVER SPORT II (L494)	04/13 > 03/22	BPW-032	POSTERIORE (REAR)	LR033295	951 mm.
RANGE ROVER SPORT II (L494)	10/17 > 03/22	BPW-087	POSTERIORE (REAR)	LR084071	940 mm.
RANGE ROVER SPORT III (L461)	04/22 >	BPW-304	ANTERIORE (FRONT)	LR153546	550 mm.
RANGE ROVER VELAR (L560)	03/17 >	BPW-130	POSTERIORE (REAR)	T4A3216	1015 mm.

APPLICAZIONE (APPLICATION)	ANNO (YEAR)	CODICE (CODE)	LATO (SIDE)	O.E. (OR. NUMBER)	LUNGH. (LENGHT)
190 (W201)	10/82 > 08/93	BPW-054	ANTERIORE (FRONT)	A2015400317	150 mm.
200 (W124)	04/85 > 06/93	BPW-054	ANTERIORE (FRONT)	A2015400317	150 mm.
CLASSE A (W168)	07/97 > 08/04	BPW-025	ANT. - POST. (FRONT - REAR)	A0005400217 A1265402017 A1405401217	90 mm.
CLASSE A (W169)	09/04 > 06/12	BPW-003	ANT. - POST. (FRONT - REAR)	A2205400617 A2205400717	98 mm.
CLASSE A (W176)	06/12 > 05/18	BPW-005	ANTERIORE (FRONT)	A1695401617	93 mm.
CLASSE A (W177)	03/18 >	BPW-005	ANTERIORE (FRONT)	A1695401617	93 mm.
CLASSE B (W245)	03/05 > 11/11	BPW-003	ANT. - POST. (FRONT - REAR)	A2205400617 A2205400717	98 mm.
CLASSE B (W246)	11/11 > 12/18	BPW-005	ANTERIORE (FRONT)	A1695401617	93 mm.
CLASSE B (W247)	12/18 >	BPW-005	ANTERIORE (FRONT)	A1695401617	93 mm.
CLASSE C (W203)	05/00 > 02/07	BPW-003	ANT. - POST. (FRONT - REAR)	A2205400617 A2205400717	98 mm.
CLASSE C (W204)	01/07 > 03/14	BPW-003	ANT. - POST. (FRONT - REAR)	A2205400617 A2205400717	98 mm.
CLASSE C (W204)	01/07 > 03/14	BPW-295	ANTERIORE (FRONT)	A1715400617	117 mm.
CLASSE C (W205)	12/13 > 06/21	BPW-005	ANTERIORE (FRONT)	A1695401617	93 mm.
CLASSE C (W206)	03/21 >	BPW-005	ANTERIORE (FRONT)	A1695401617	93 mm.
CLASSE C (W206)	03/21 >	BPW-019	ANTERIORE (FRONT)	A2319050014	100 mm.
CLASSE CLC (CL203)	05/08 > 06/11	BPW-003	ANT. - POST. (FRONT - REAR)	A2205400617 A2205400717	98 mm.

APPLICAZIONE (APPLICATION)	ANNO (YEAR)	CODICE (CODE)	LATO (SIDE)	O.E. (OR. NUMBER)	LUNGH. (LENGHT)
CLASSE E (W124)	06/93 > 03/98	BPW-054	ANTERIORE (FRONT)	A2015400317	150 mm.
CLASSE E (W210)	02/96 > 03/03	BPW-025	ANT. - POST. (FRONT - REAR)	A0005400217 A1265402017 A1405401217	90 mm.
CLASSE E (W211)	03/02 > 12/08	BPW-001	ANT. - POST. (FRONT - REAR)	A1645401017 A2205401517	95 mm.
CLASSE E (W211)	03/02 > 12/08	BPW-003	ANT. - POST. (FRONT - REAR)	A2205400617 A2205400717	98 mm.
CLASSE E (W211)	03/02 > 12/08	BPW-002	ANTERIORE (FRONT)	A2115400717	100 mm.
CLASSE E (W211)	03/02 > 12/08	BPW-295	ANTERIORE (FRONT)	A1715400617	117 mm.
CLASSE E (W212)	01/09 > 12/16	BPW-003	ANT. - POST. (FRONT - REAR)	A2205400617 A2205400717	98 mm.
CLASSE E (W212)	01/09 > 12/16	BPW-295	ANTERIORE (FRONT)	A1715400617	117 mm.
CLASSE E (W213)	01/17 > 10/23	BPW-005	ANTERIORE (FRONT)	A1695401617	93 mm.
CLASSE E (W213)	01/17 > 10/23	BPW-003	ANT. - POST. (FRONT - REAR)	A2205400617 A2205400717	98 mm.
CLASSE E (W213)	01/17 > 10/23	BPW-019	ANTERIORE (FRONT)	A2319050014	100 mm.
CLASSE E (W213)	01/17 > 10/23	BPW-295	ANTERIORE (FRONT)	A1715400617	117 mm.
CLASSE G (W463)	04/99 > 04/18	BPW-005	ANTERIORE (FRONT)	A1695401617	93 mm.
CLASSE G (W463)	04/99 > 04/18	BPW-001	ANT. - POST. (FRONT - REAR)	A1645401017 A2205401517	95 mm.
CLASSE G (W463)	04/99 > 04/18	BPW-003	ANT. - POST. (FRONT - REAR)	A2205400617 A2205400717	98 mm.
CLASSE G (W463)	08/96 > 12/15	BPW-012	ANT. - POST. (FRONT - REAR)	A9015400017 A9015400117	210 mm.

APPLICAZIONE (APPLICATION)	ANNO (YEAR)	CODICE (CODE)	LATO (SIDE)	O.E. (OR. NUMBER)	LUNGH. (LENGHT)
CLASSE G (W463)	08/96 > 12/15	BPW-012	ANT. - POST. (FRONT - REAR)	A9015400017 A9015400117	210 mm.
CLASSE G (W463)	08/96 > 12/15	BPW-154	ANTERIORE (FRONT)	A2025400717	150 mm.
CLASSE G (W463)	08/96 > 12/15	BPW-295	ANTERIORE (FRONT)	A1715400617	117 mm.
CLASSE GL (X164)	09/06 > 12/12	BPW-001	ANT. - POST. (FRONT - REAR)	A1645401017 A2205401517	95 mm.
CLASSE GL (X166)	07/12 > 10/15	BPW-001	ANT. - POST. (FRONT - REAR)	A1645401017 A2205401517	95 mm.
CLASSE GL (X166)	07/12 > 10/15	BPW-003	ANT. - POST. (FRONT - REAR)	A2205400617 A2205400717	98 mm.
CLASSE GL (X166)	07/12 > 10/15	BPW-295	ANTERIORE (FRONT)	A1715400617	117 mm.
CLASSE GLA (X156)	12/13 > 12/19	BPW-005	ANTERIORE (FRONT)	A1695401617	93 mm.
CLASSE GLK (X204)	12/08 > 06/15	BPW-003	ANT. - POST. (FRONT - REAR)	A2205400617 A2205400717	98 mm.
CLASSE M (W163)	02/98 > 06/05	BPW-107	ANTERIORE (FRONT)	A1635401517 A1635401717	112 mm.
CLASSE M (W163)	02/98 > 06/05	BPW-154	ANTERIORE (FRONT)	A2025400717	150 mm.
CLASSE M (W163)	02/98 > 06/05	BPW-320	ANTERIORE (FRONT)	A1635401317	184 mm.
CLASSE M (W163)	02/98 > 06/05	BPW-319	POSTERIORE (REAR)	A1635401417	310 mm.
CLASSE M (W164)	07/05 > 12/11	BPW-001	ANT. - POST. (FRONT - REAR)	A1645401017 A2205401517	95 mm.
CLASSE M (W166)	06/11 > 12/15	BPW-001	ANT. - POST. (FRONT - REAR)	A1645401017 A2205401517	95 mm.
CLASSE M (W166)	06/11 > 12/15	BPW-003	ANT. - POST. (FRONT - REAR)	A2205400617 A2205400717	98 mm.

APPLICAZIONE (APPLICATION)	ANNO (YEAR)	CODICE (CODE)	LATO (SIDE)	O.E. (OR. NUMBER)	LUNGH. (LENGHT)
CLASSE M (W166)	06/11 > 12/15	BPW-295	ANTERIORE (FRONT)	A1715400617	117 mm.
CLASSE R (W251)	07/05 > 12/14	BPW-001	ANT. - POST. (FRONT - REAR)	A1645401017 A2205401517	95 mm.
CLASSE S (W220)	09/02 > 08/05	BPW-001	ANT. - POST. (FRONT - REAR)	A1645401017 A2205401517	95 mm.
CLASSE S (W220)	09/02 > 08/05	BPW-003	ANT. - POST. (FRONT - REAR)	A2205400617 A2205400717	98 mm.
CLASSE S (W220)	09/02 > 08/05	BPW-002	ANTERIORE (FRONT)	A2115400717	100 mm.
CLASSE S (W221)	10/05 > 12/13	BPW-003	ANT. - POST. (FRONT - REAR)	A2205400617 A2205400717	98 mm.
CLASSE S (W221)	10/05 > 12/13	BPW-295	ANTERIORE (FRONT)	A1715400617	117 mm.
CLASSE S (W222)	05/13 > 07/20	BPW-003	ANT. - POST. (FRONT - REAR)	A2205400617 A2205400717	98 mm.
CLASSE S (W222)	05/13 > 07/20	BPW-295	ANTERIORE (FRONT)	A1715400617	117 mm.
CLASSE S (W223)	09/20 > 06/23	BPW-005	ANTERIORE (FRONT)	A1695401617	93 mm.
CLASSE S (W223)	09/20 > 06/23	BPW-019	ANTERIORE (FRONT)	A2319050014	100 mm.
CLASSE V (W638/2)	09/96 > 07/03	BPW-012	ANT. - POST. (FRONT - REAR)	A9015400017 A9015400117	210 mm.
CLASSE V (W638/2)	09/96 > 07/03	BPW-061	ANT. - POST. (FRONT - REAR)	A9015400217 A9015400317	190 mm.
CLASSE V (W447)	03/14 >	BPW-004	ANT. - POST. (FRONT - REAR)	A9065401417 A9065401517	105 mm.
CLA (C117)	01/13 > 13/19	BPW-005	ANTERIORE (FRONT)	A1695401617	93 mm.
CLA (C118)	03/19 >	BPW-005	ANTERIORE (FRONT)	A1695401617	93 mm.

APPLICAZIONE (APPLICATION)	ANNO (YEAR)	CODICE (CODE)	LATO (SIDE)	O.E. (OR. NUMBER)	LUNGH. (LENGHT)
CLK (C209)	06/02 > 03/10	BPW-003	ANT. - POST. (FRONT - REAR)	A2205400617 A2205400717	98 mm.
CLK (C209)	06/02 > 03/10	BPW-002	ANTERIORE (FRONT)	A2115400717	100 mm.
CLK (C209)	06/02 > 03/10	BPW-295	ANTERIORE (FRONT)	A1715400617	117 mm.
CLS (C218)	01/11 > 12/17	BPW-003	ANT. - POST. (FRONT - REAR)	A2205400617 A2205400717	98 mm.
CLS (C218)	01/11 > 12/17	BPW-295	ANTERIORE (FRONT)	A1715400617	117 mm.
CLS (C257)	12/17 >	BPW-005	ANTERIORE (FRONT)	A1695401617	93 mm.
CLS (C219)	10/04 > 12/10	BPW-003	ANT. - POST. (FRONT - REAR)	A2205400617 A2205400717	98 mm.
CLS (C219)	10/04 > 12/10	BPW-002	ANTERIORE (FRONT)	A2115400717	100 mm.
CLS (C219)	10/04 > 12/10	BPW-019	ANTERIORE (FRONT)	A2319050014	100 mm.
CLS (C219)	10/04 > 12/10	BPW-295	ANTERIORE (FRONT)	A1715400617	117 mm.
EQA - EQB - EQC - EQE - EQS	02/21 >	BPW-005	ANTERIORE (FRONT)	A1695401617	93 mm.
EQV (W447)	11/21 >	BPW-004	ANT. - POST. (FRONT - REAR)	A9065401417 A9065401517	105 mm.
GLA (H247)	02/20 >	BPW-005	ANTERIORE (FRONT)	A1695401617	93 mm.
GLB (X247)	08/19 >	BPW-005	ANTERIORE (FRONT)	A1695401617	93 mm.
GLC (X253)	06/15 > 06/22	BPW-005	ANTERIORE (FRONT)	A1695401617	93 mm.
GLC (X253)	06/15 > 06/22	BPW-295	ANTERIORE (FRONT)	A1715400617	117 mm.

N.B.: I CODICI O.E. ED IL LORO TESTO SONO RIPORTATI SOLO A TITOLO INDICATIVO
THE O.E. CODES AND THEIR TEXT ARE REPORTED ONLY FOR INDICATIVE PURPOSE

APPLICAZIONE (APPLICATION)	ANNO (YEAR)	CODICE (CODE)	LATO (SIDE)	O.E. (OR. NUMBER)	LUNGH. (LENGHT)
GLC (X254)	06/22 >	BPW-005	ANTERIORE (FRONT)	A1695401617	93 mm.
GLC COUPE' (C253)	06/16 > 03/23	BPW-005	ANTERIORE (FRONT)	A1695401617	93 mm.
GLC COUPE' (C253)	06/16 > 03/23	BPW-295	ANTERIORE (FRONT)	A1715400617	117 mm.
GLE (W166)	04/15 > 10/18	BPW-001	ANT. - POST. (FRONT - REAR)	A1645401017 A2205401517	95 mm.
GLE (W166)	04/15 > 10/18	BPW-003	ANT. - POST. (FRONT - REAR)	A2205400617 A2205400717	98 mm.
GLE (W166)	04/15 > 10/18	BPW-295	ANTERIORE (FRONT)	A1715400617	117 mm.
GLE (V167)	10/18 >	BPW-005	ANTERIORE (FRONT)	A1695401617	93 mm.
GLE (V167)	10/18 >	BPW-295	ANTERIORE (FRONT)	A1715400617	117 mm.
GLE COUPE' (C292)	03/15 > 10/19	BPW-001	ANT. - POST. (FRONT - REAR)	A1645401017 A2205401517	95 mm.
GLE COUPE' (C292)	03/15 > 10/19	BPW-003	ANT. - POST. (FRONT - REAR)	A2205400617 A2205400717	98 mm.
GLE COUPE' (C167)	11/19 >	BPW-005	ANTERIORE (FRONT)	A1695401617	93 mm.
GLS (X166)	11/15 > 04/19	BPW-001	ANT. - POST. (FRONT - REAR)	A1645401017 A2205401517	95 mm.
GLS (X166)	11/15 > 04/19	BPW-003	ANT. - POST. (FRONT - REAR)	A2205400617 A2205400717	98 mm.
GLS (X166)	11/15 > 04/19	BPW-295	ANTERIORE (FRONT)	A1715400617	117 mm.
GLS (X167)	04/19 >	BPW-005	ANTERIORE (FRONT)	A1695401617	93 mm.
GLS (X167)	04/19 >	BPW-295	ANTERIORE (FRONT)	A1715400617	117 mm.

N.B.: I CODICI O.E. ED IL LORO TESTO SONO RIPORTATI SOLO A TITOLO INDICATIVO
THE O.E. CODES AND THEIR TEXT ARE REPORTED ONLY FOR INDICATIVE PURPOSE

APPLICAZIONE (APPLICATION)	ANNO (YEAR)	CODICE (CODE)	LATO (SIDE)	O.E. (OR. NUMBER)	LUNGH. (LENGHT)
SL (R230)	10/01 > 01/12	BPW-003	ANT. - POST. (FRONT - REAR)	A2205400617 A2205400717	98 mm.
SL (R230)	10/01 > 01/12	BPW-295	ANTERIORE (FRONT)	A1715400617	117 mm.
SL (R231)	02/12 > 04/20	BPW-003	ANT. - POST. (FRONT - REAR)	A2205400617 A2205400717	98 mm.
SL (R231)	02/12 > 04/20	BPW-019	ANTERIORE (FRONT)	A2319050014	100 mm.
SL (R231)	02/12 > 04/20	BPW-295	ANTERIORE (FRONT)	A1715400617	117 mm.
SL (R232)	03/22 >	BPW-005	ANTERIORE (FRONT)	A1695401617	93 mm.
SLC (R172)	01/16 >	BPW-003	ANT. - POST. (FRONT - REAR)	A2205400617 A2205400717	98 mm.
SLK (R170)	03/00 > 04/04	BPW-025	ANT. - POST. (FRONT - REAR)	A0005400217 A1265402017 A1405401217	90 mm.
SLK (R171)	03/04 > 02/11	BPW-003	ANT. - POST. (FRONT - REAR)	A2205400617 A2205400717	98 mm.
SLK (R171)	03/04 > 02/11	BPW-002	ANTERIORE (FRONT)	A2115400717	100 mm.
SLK (R171)	03/04 > 02/11	BPW-295	ANTERIORE (FRONT)	A1715400617	117 mm.
SLK (R172)	02/11 >	BPW-003	ANT. - POST. (FRONT - REAR)	A2205400617 A2205400717	98 mm.
SPRINTER 2T (B901 - B902)	02/95 > 05/06	BPW-012	ANT. - POST. (FRONT - REAR)	A9015400017 A9015400117	210 mm.
SPRINTER 2T (B901 - B902)	02/95 > 05/06	BPW-061	ANT. - POST. (FRONT - REAR)	A9015400217 A9015400317	190 mm.
SPRINTER 3T (B903)	02/95 > 05/06	BPW-012	ANT. - POST. (FRONT - REAR)	A9015400017 A9015400117	210 mm.
SPRINTER 3T (B903)	02/95 > 05/06	BPW-061	ANT. - POST. (FRONT - REAR)	A9015400217 A9015400317	190 mm.

APPLICAZIONE (APPLICATION)	ANNO (YEAR)	CODICE (CODE)	LATO (SIDE)	O.E. (OR. NUMBER)	LUNGH. (LENGHT)
SPRINTER 3-T - 3,5-T (B906)	06/06 > 12/18	BPW-004	ANT. - POST. (FRONT - REAR)	A9065401417 A9065401517	105 mm.
SPRINTER 3-T - 3,5-T (B906 - B907 - B910)	06/06 > 12/18	BPW-007	ANT. - POST. (FRONT - REAR)	A9065401417 A9065401517	95 mm.
SPRINTER 3-T - 3,5-T (B907 - 910)	02/18 > 12/23	BPW-004	ANT. - POST. (FRONT - REAR)	A9065401417 A9065401517	105 mm.
SPRINTER 4T (B904)	02/96 > 05/06	BPW-012	ANT. - POST. (FRONT - REAR)	A9015400017 A9015400117	210 mm.
SPRINTER 4T (B904)	02/96 > 05/06	BPW-061	ANT. - POST. (FRONT - REAR)	A9015400217 A9015400317	190 mm.
SPRINTER 4-T - 4,6-T (B906)	06/06 > 12/18	BPW-004	ANT. - POST. (FRONT - REAR)	A9065401417 A9065401517	105 mm.
SPRINTER 4-T - 4,6-T (B906 - B907 - B910)	06/06 > 12/18	BPW-007	ANT. - POST. (FRONT - REAR)	A9065401417 A9065401517	95 mm.
SPRINTER 4,6-T (B906)	03/09 > 12/18	BPW-018	POSTERIORE (REAR)	A9065401317	85 mm.
SPRINTER 5-T (B906)	06/06 > 12/16	BPW-004	ANT. - POST. (FRONT - REAR)	A9065401417 A9065401517	105 mm.
SPRINTER 5-T (B906)	06/06 > 12/16	BPW-007	ANT. - POST. (FRONT - REAR)	A9065401417 A9065401517	95 mm.
SPRINTER 5-T (B906)	06/06 > 12/16	BPW-018	POSTERIORE (REAR)	A9065401317	85 mm.
VANEO (414)	02/02 > 07/05	BPW-003	ANT. - POST. (FRONT - REAR)	A2205400617 A2205400717	98 mm.
VIANO (W639)	09/03 > 08/14	BPW-004	ANT. - POST. (FRONT - REAR)	A9065401417 A9065401517	105 mm.
VIANO (W639)	09/03 > 08/14	BPW-007	ANT. - POST. (FRONT - REAR)	A9065401417 A9065401517	95 mm.
VITO (W638)	02/96 > 07/03	BPW-012	ANT. - POST. (FRONT - REAR)	A9015400017 A9015400117	210 mm.
VITO (W638)	02/96 > 07/03	BPW-061	ANT. - POST. (FRONT - REAR)	A9015400217 A9015400317	190 mm.

APPLICAZIONE (APPLICATION)	ANNO (YEAR)	CODICE (CODE)	LATO (SIDE)	O.E. (OR. NUMBER)	LUNGH. (LENGTH)
MINI (R50 - R53) MINI CABRIO (R52)	06/01 > 11/07	BPW-096	ANTERIORE (FRONT)	34356761447 34356778175	885 mm.
MINI (R50 - R53) MINI CABRIO (R52)	06/01 > 11/07	BPW-090	POSTERIORE (REAR)	34356761448	1095 mm.
MINI (R56) MINI CABRIO (R57)	10/06 > 06/15	BPW-067	ANTERIORE (FRONT)	34356792572	800 mm.
MINI (R56) MINI CABRIO (R57)	10/06 > 06/15	BPW-086	ANTERIORE (FRONT)	34356773017 34356783230 34356789329	802 mm.
MINI (R56) MINI CABRIO (R57)	10/06 > 06/15	BPW-059	POSTERIORE (REAR)	34356792573	1128 mm.
MINI (R56 - R57) (C./SENSORE CURVO)	10/06 > 06/15	BPW-077	POSTERIORE (REAR)	34356773018 34356783772 34356789330	1127 mm.
MINI COUPE' (R58) MINI ROADSTER (R59)	12/10 > 05/15	BPW-067	ANTERIORE (FRONT)	34356792572	800 mm.
MINI COUPE' (R58) MINI ROADSTER (R59)	12/10 > 05/15	BPW-059	POSTERIORE (REAR)	34356792573	1128 mm.
MINI (F55)	09/13 >	BPW-034	ANTERIORE (FRONT)	34356799735 34356887151 34356887827	435 mm.
MINI (F55)	09/13 >	BPW-011	POSTERIORE (REAR)	34356865612 34356799736	655 mm.
MINI (F56)	12/13 >	BPW-034	ANTERIORE (FRONT)	34356799735 34356887151 34356887827	435 mm.
MINI (F56)	12/13 >	BPW-011	POSTERIORE (REAR)	34356865612 34356799736	655 mm.
MINI COOPER (F56)	12/13 >	BPW-015	ANTERIORE (FRONT)	34356888167 34356865613 34351543830	655 mm.
MINI CABRIO (F57)	11/14 >	BPW-034	ANTERIORE (FRONT)	34356799735 34356887151 34356887827	435 mm.
MINI CABRIO (F57)	11/14 >	BPW-011	POSTERIORE (REAR)	34356865612 34356799736	655 mm.
MINI CLUBMAN (R55)	08/07 > 14	BPW-086	ANTERIORE (FRONT)	34356773017 34356783230 34356789329	802 mm.

N.B.: I CODICI O.E. ED IL LORO TESTO SONO RIPORTATI SOLO A TITOLO INDICATIVO
THE O.E. CODES AND THEIR TEXT ARE REPORTED ONLY FOR INDICATIVE PURPOSE

APPLICAZIONE (APPLICATION)	ANNO (YEAR)	CODICE (CODE)	LATO (SIDE)	O.E. (OR. NUMBER)	LUNGH. (LENGHT)
MINI CLUBMAN (R55)	08/07 > 14	BPW-059	POSTERIORE (REAR)	34356792573	1128 mm.
MINI CLUBMAN (R55) (C./SENSORE CURVO)	08/07 > 14	BPW-077	POSTERIORE (REAR)	34356773018 34356783772 34356789330	1127 mm.
MINI CLUBMAN (F54)	12/14 >	BPW-015	ANTERIORE (FRONT)	34356888167 34356865613 34351543830	655 mm.
MINI CLUBMAN (F54)	12/14 >	BPW-011	POSTERIORE (REAR)	34356865612 34356799736	655 mm.
MINI COUNTRYMAN (R60)	08/10 > 10/16	BPW-068	ANTERIORE (FRONT)	34359804833	910 mm.
MINI COUNTRYMAN (R60)	08/10 > 10/16	BPW-065	POSTERIORE (REAR)	34359804834	950 mm.
MINI COUNTRYMAN (F60)	10/16 >	BPW-034	ANTERIORE (FRONT)	34356799735 34356887151 34356887827	435 mm.
MINI COUNTRYMAN (F60)	10/16 >	BPW-011	POSTERIORE (REAR)	34356865612 34356799736	655 mm.
MINI COUNTRYMAN COOPER (F60)	10/16 >	BPW-015	ANTERIORE (FRONT)	34356888167 34356865613 34351543830	655 mm.
MINI PACEMAN (R61)	03/12 > 10/16	BPW-068	ANTERIORE (FRONT)	34359804833	910 mm.
MINI PACEMAN (R61)	03/12 > 10/16	BPW-065	POSTERIORE (REAR)	34359804834	950 mm.

APPLICAZIONE (APPLICATION)	ANNO (YEAR)	CODICE (CODE)	LATO (SIDE)	O.E. (OR. NUMBER)	LUNGH. (LENGHT)
ASCONA C	09/81 > 08/88	BPW-302	ANTERIORE (FRONT)	1238353	955 mm.
ASTRA F (T.T.)	09/91 > 09/98	BPW-252	ANTERIORE (FRONT)	90335784	670 mm.
ASTRA F (T.T.)	09/91 > 09/98	BPW-292	ANTERIORE (FRONT)	1238984 6238399	685 mm.
ASTRA G (T.T.)	02/98 > 10/05	BPW-162	ANTERIORE (FRONT)	1238442 6238075	720 mm.
ASTRA G (T.T.)	02/98 > 10/05	BPW-246	ANTERIORE (FRONT)	6235674	770 mm.
ASTRA H (T.T.)	03/04 > 10/10	BPW-141	ANTERIORE (FRONT)	6235647	290 mm.
CALIBRA A	08/89 > 07/97	BPW-252	ANTERIORE (FRONT)	90335784	670 mm.
CALIBRA A	08/89 > 07/97	BPW-292	ANTERIORE (FRONT)	1238984 6238399	685 mm.
KADETT D - E	08/79 > 02/93	BPW-302	ANTERIORE (FRONT)	1238353	955 mm.
MANTA B	08/77 > 08/88	BPW-302	ANTERIORE (FRONT)	1238353	955 mm.
OMEGA A (T.T.)	09/86 > 03/94	BPW-302	ANTERIORE (FRONT)	1238353	955 mm.
OMEGA B (T.T.)	03/94 > 07/03	BPW-175	ANTERIORE (FRONT)	6238323	730 mm.
OMEGA B (T.T.)	03/94 > 07/03	BPW-307	ANTERIORE (FRONT)	6238322	730 mm.
REKORD E S.W.	11/82 > 08/86	BPW-302	ANTERIORE (FRONT)	1238353	955 mm.
SIGNUM	05/03 > 12/08	BPW-141	ANTERIORE (FRONT)	6235647	290 mm.
SIGNUM	05/03 > 12/08	BPW-226	ANTERIORE (FRONT)	6238230	685 mm.

N.B.: I CODICI O.E. ED IL LORO TESTO SONO RIPORTATI SOLO A TITOLO INDICATIVO
THE O.E. CODES AND THEIR TEXT ARE REPORTED ONLY FOR INDICATIVE PURPOSE

APPLICAZIONE (APPLICATION)	ANNO (YEAR)	CODICE (CODE)	LATO (SIDE)	O.E. (OR. NUMBER)	LUNGH. (LENGHT)
VECTRA A (T.T.)	09/88 > 11/95	BPW-252	ANTERIORE (FRONT)	90335784	670 mm.
VECTRA A (T.T.)	09/88 > 11/95	BPW-292	ANTERIORE (FRONT)	1238984 6238399	685 mm.
VECTRA A (T.T.)	09/88 > 11/95	BPW-301	ANTERIORE (FRONT)	1238349 1238408	660 mm.
VECTRA B (T.T.)	10/95 > 07/03	BPW-180	ANTERIORE (FRONT)	90497051	660 mm.
VECTRA B (T.T.)	10/95 > 07/03	BPW-293	ANTERIORE (FRONT)	6238389	660 mm.
VECTRA C (T.T.)	04/02 > 01/09	BPW-141	ANTERIORE (FRONT)	6235647	290 mm.
VECTRA C (T.T.)	04/02 > 01/09	BPW-226	ANTERIORE (FRONT)	6238230	685 mm.
ZAFIRA A (T.T.)	04/99 > 06/05	BPW-162	ANTERIORE (FRONT)	1238442 6238075	720 mm.
ZAFIRA A (T.T.)	04/99 > 06/05	BPW-246	ANTERIORE (FRONT)	6235674	770 mm.
ZAFIRA B (T.T.)	07/05 > 04/15	BPW-141	ANTERIORE (FRONT)	6235647	290 mm.

N.B.: I CODICI O.E. ED IL LORO TESTO SONO RIPORTATI SOLO A TITOLO INDICATIVO
THE O.E. CODES AND THEIR TEXT ARE REPORTED ONLY FOR INDICATIVE PURPOSE

APPLICAZIONE (APPLICATION)	ANNO (YEAR)	CODICE (CODE)	LATO (SIDE)	O.E. (OR. NUMBER)	LUNGH. (LENGHT)
911 (996)	08/97 > 09/05	BPW-177	ANTERIORE (FRONT)	99661236500	440 mm.
911 (996)	08/97 > 09/05	BPW-329	POSTERIORE (REAR)	99661234700	557 mm.
911 (997)	07/04 > 12/08	BPW-177	ANTERIORE (FRONT)	99661236500	440 mm.
911 (997)	07/04 > 12/08	BPW-265	ANTERIORE (FRONT)	99761267800	390 mm.
911 (997) (LATO DX)	03/06 > 12/12	BPW-333	ANTERIORE (FRONT)	99761275900	369,6 mm.
911 (997) (LATO SX)	03/06 > 12/12	BPW-332	ANTERIORE (FRONT)	99761275600	349,6 mm.
911 (997)	03/06 > 12/12	BPW-324	ANT. - POST. (FRONT - REAR)	99761275700	365 mm.
911 (997)	03/06 > 12/12	BPW-329	POSTERIORE (REAR)	99661234700	557 mm.
BOXER (986)	09/96 > 12/04	BPW-177	ANTERIORE (FRONT)	99661236500	440 mm.
BOXER (986 - 987)	09/96 > 12/09	BPW-164	ANTERIORE (FRONT)	98661236500	440 mm.
BOXER (987) (LATO DX)	11/04 > 12/06	BPW-333	ANTERIORE (FRONT)	99761275900	369,6 mm.
BOXER (987) (LATO SX)	11/04 > 12/06	BPW-332	ANTERIORE (FRONT)	99761275600	349,6 mm.
BOXER (987)	11/04 > 12/06	BPW-324	ANT. - POST. (FRONT - REAR)	99761275700	365 mm.
BOXER (987)	11/04 > 12/06	BPW-327	POSTERIORE (REAR)	98761267601	510 mm.
CAYENNE (9PA)	09/02 > 09/10	BPW-014	ANTERIORE (FRONT)	95561236500	420 mm.
CAYENNE (9PA)	09/02 > 09/10	BPW-021	POSTERIORE (REAR)	95561236520 95561236530	255 mm.

N.B.: I CODICI O.E. ED IL LORO TESTO SONO RIPORTATI SOLO A TITOLO INDICATIVO
THE O.E. CODES AND THEIR TEXT ARE REPORTED ONLY FOR INDICATIVE PURPOSE

APPLICAZIONE (APPLICATION)	ANNO (YEAR)	CODICE (CODE)	LATO (SIDE)	O.E. (OR. NUMBER)	LUNGH. (LENGHT)
CAYENNE (9PA)	09/02 > 09/10	BPW-321	POSTERIORE (REAR)	95561236572	245 mm.
CAYENNE (92A)	06/10 >	BPW-042	ANTERIORE (FRONT)	95861236500	296 mm.
CAYENNE (92A)	06/10 >	BPW-193	ANTERIORE (FRONT)	95561236560	375 mm.
CAYENNE (92A)	06/10 >	BPW-027	POSTERIORE (REAR)	95861236550	140 mm.
CAYMAN (987)	11/05 > 06/13	BPW-164	ANTERIORE (FRONT)	98661236500	440 mm.
CAYMAN (987)	07/06 > 12/09	BPW-324	ANT. - POST. (FRONT - REAR)	99761275700	365 mm.
CAYMAN (987)	11/05 > 06/13	BPW-327	POSTERIORE (REAR)	98761267601	510 mm.
MACAN (95B)	02/14 >	BPW-092	ANTERIORE (FRONT)	95B907253A	295 mm.
MACAN (95B)	02/14 >	BPW-101	ANTERIORE (FRONT)	95B907253	245 mm.
MACAN (95B)	02/14 >	BPW-300	POSTERIORE (REAR)	4G0615121	215 mm.
PANAREMA (970)	05/10 > 10/16	BPW-042	ANTERIORE (FRONT)	95861236500	296 mm.
PANAREMA (970)	05/10 > 10/16	BPW-193	ANTERIORE (FRONT)	95561236560	375 mm.
PANAREMA (970)	05/10 > 10/16	BPW-027	POSTERIORE (REAR)	95861236550	140 mm.
PANAREMA (971)	05/16 > 12/23	BPW-036	ANTERIORE (FRONT)	9A790763700	326 mm.
PANAREMA (971)	05/16 > 12/23	BPW-193	ANTERIORE (FRONT)	95561236560	375 mm.

APPLICAZIONE (APPLICATION)	ANNO (YEAR)	CODICE (CODE)	LATO (SIDE)	O.E. (OR. NUMBER)	LUNGH. (LENGHT)
ARTEON (3H7 - 3H8)	03/17 >	BPW-312	ANTERIORE (FRONT)	8V0615437	170 mm.
CRAFTER 30-35 (2E - 2F)	04/06 > 12/16	BPW-004	ANT. - POST. (FRONT - REAR)	2E0906206A 2E0906206C	105 mm.
CRAFTER 30-35 (2E - 2F)	04/06 > 12/16	BPW-007	ANT. - POST. (FRONT - REAR)	2E0906206G	95 mm.
CRAFTER 30-50 (2E - 2F)	04/06 > 12/16	BPW-018	POSTERIORE (REAR)	2E0906206B	85 mm.
CRAFTER (SY - SX - SZ)	09/16 >	BPW-127	POSTERIORE (REAR)	2N0615437 2N0615437B	220 mm.
CRAFTER (SY - SX - SZ)	09/16 >	BPW-129	POSTERIORE (REAR)	65259370001	280 mm.
GOLF IV	09/02 > 06/05	BPW-184	ANTERIORE (FRONT)	1J0615121	270 mm.
GOLF VII (5G1 - BQ1 - BE1 - BE2)	08/12 > 08/20	BPW-312	ANTERIORE (FRONT)	8V0615437	170 mm.
GOLF VII SPORTVAN (AM1 - AN1)	02/14 > 08/20	BPW-312	ANTERIORE (FRONT)	8V0615437	170 mm.
GOLF VII VARIANT (BA5 - BV5)	04/13 > 08/20	BPW-312	ANTERIORE (FRONT)	8V0615437	170 mm.
GOLF VIII (CD1 - DA1)	08/19 >	BPW-312	ANTERIORE (FRONT)	8V0615437	170 mm.
GOLF VIII VARIANT (CG5 - DB5)	08/20 >	BPW-312	ANTERIORE (FRONT)	8V0615437	170 mm.
LT 28-35 II	05/96 > 07/06	BPW-012	ANT. - POST. (FRONT - REAR)	2D0919351	210 mm.
LT 28-35 II	05/96 > 07/06	BPW-061	ANT. - POST. (FRONT - REAR)	2D0919351A	190 mm.
LT 28-46 II	05/96 > 07/06	BPW-012	ANT. - POST. (FRONT - REAR)	2D0919351	210 mm.
LT 28-46 II	05/96 > 07/06	BPW-061	ANT. - POST. (FRONT - REAR)	2D0919351A	190 mm.

N.B.: I CODICI O.E. ED IL LORO TESTO SONO RIPORTATI SOLO A TITOLO INDICATIVO
THE O.E. CODES AND THEIR TEXT ARE REPORTED ONLY FOR INDICATIVE PURPOSE

APPLICAZIONE (APPLICATION)	ANNO (YEAR)	CODICE (CODE)	LATO (SIDE)	O.E. (OR. NUMBER)	LUNGH. (LENGHT)
PASSAT (B5) PASSAT VARIANT (B5)	09/01 > 09/04	BPW-317	ANTERIORE (FRONT)	3B7615121	245 mm.
PASSAT (B8) PASSAT VARIANT (B8)	08/14 >	BPW-312	ANTERIORE (FRONT)	8V0615437	170 mm.
TIGUAN (AD1 - AX1) TIGUAN ALLSPACE (BW2 - BJ2)	01/16 >	BPW-312	ANTERIORE (FRONT)	8V0615437	170 mm.
TOUAREG (7LA - 7L6 - 7L7)	10/02 > 05/10	BPW-014	ANTERIORE (FRONT)	7L0907637 8J0615437	420 mm.
TOUAREG (7LA - 7L6 - 7L7)	10/02 > 05/10	BPW-021	POSTERIORE (REAR)	7L0907637B 7L0907637C	255 mm.
TOUAREG (7P5 - 7P6)	01/10 > 03/18	BPW-036	ANTERIORE (FRONT)	7P0907637	326 mm.
TOUAREG (7P5 - 7P6)	01/10 > 03/18	BPW-042	ANTERIORE (FRONT)	7P0907637A	296 mm.
TOUAREG (7P5 - 7P6)	01/10 > 03/18	BPW-027	POSTERIORE (REAR)	7P0907637C	140 mm.
TOUAREG (CR7 - RC8)	11/17 >	BPW-031	ANTERIORE (FRONT)	4M0615121R 4M0615121S 4M0615121AB	400 mm.
TOUAREG (CR7 - RC8)	11/17 >	BPW-041	POSTERIORE (REAR)	4M0615121P 8W0615121E	390 mm.
TOURAN (5T1)	05/15 >	BPW-312	ANTERIORE (FRONT)	8V0615437	170 mm.
T-ROC (AD1) T-ROC CABRIO (AC7 - AC8)	07/17 >	BPW-312	ANTERIORE (FRONT)	8V0615437	170 mm.

IMMAGINI
IMAGES

IMMAGINI - IMAGES

BPW-001



BPW-002



BPW-003

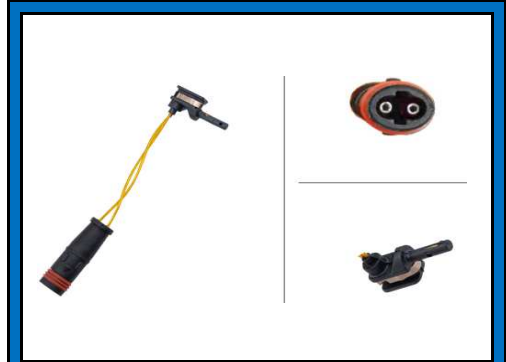

BPW-004



BPW-005



BPW-006



BPW-007



BPW-008



BPW-010



BPW-011



BPW-012



BPW-013



N.B.: I CODICI O.E. ED IL LORO TESTO SONO RIPORTATI SOLO A TITOLO INDICATIVO
THE O.E. CODES AND THEIR TEXT ARE REPORTED ONLY FOR INDICATIVE PURPOSE

IMMAGINI - IMAGES

BPW-014



BPW-015



BPW-016



BPW-018



BPW-019



BPW-021



BPW-022



BPW-025



BPW-026



BPW-027



BPW-028



BPW-029



N.B.: I CODICI O.E. ED IL LORO TESTO SONO RIPORTATI SOLO A TITOLO INDICATIVO
THE O.E. CODES AND THEIR TEXT ARE REPORTED ONLY FOR INDICATIVE PURPOSE

IMMAGINI - IMAGES

BPW-030



BPW-031



BPW-032

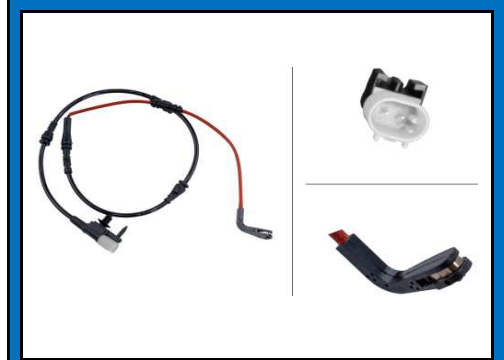

BPW-034



BPW-035



BPW-036

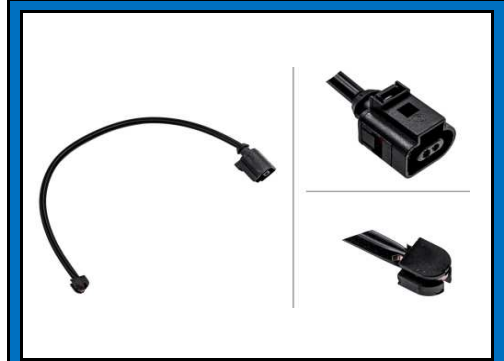

BPW-037



BPW-038



BPW-039



BPW-040



BPW-041



BPW-042



N.B.: I CODICI O.E. ED IL LORO TESTO SONO RIPORTATI SOLO A TITOLO INDICATIVO
THE O.E. CODES AND THEIR TEXT ARE REPORTED ONLY FOR INDICATIVE PURPOSE

IMMAGINI - IMAGES

BPW-043



BPW-044



BPW-045



BPW-047



BPW-049



BPW-050



BPW-051



BPW-053



BPW-054



BPW-055



BPW-056



BPW-057



N.B.: I CODICI O.E. ED IL LORO TESTO SONO RIPORTATI SOLO A TITOLO INDICATIVO
THE O.E. CODES AND THEIR TEXT ARE REPORTED ONLY FOR INDICATIVE PURPOSE

IMMAGINI - IMAGES

BPW-058



BPW-059



BPW-060



BPW-061



BPW-062



BPW-063



BPW-065



BPW-067



BPW-068



BPW-070



BPW-071



BPW-073



N.B.: I CODICI O.E. ED IL LORO TESTO SONO RIPORTATI SOLO A TITOLO INDICATIVO
THE O.E. CODES AND THEIR TEXT ARE REPORTED ONLY FOR INDICATIVE PURPOSE

IMMAGINI - IMAGES

BPW-074



BPW-076

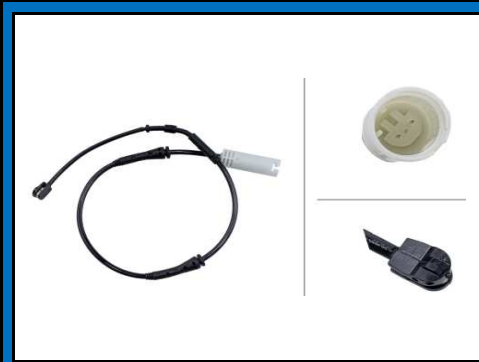

BPW-077



BPW-078



BPW-079



BPW-080

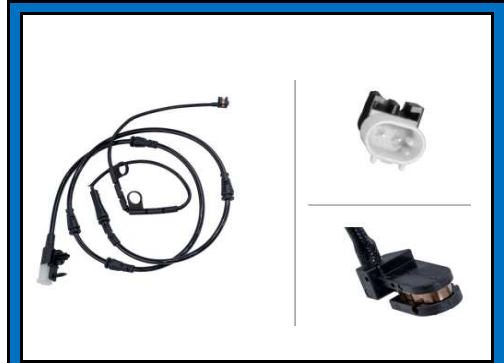

BPW-081



BPW-082



BPW-083



BPW-084



BPW-085



BPW-086



N.B.: I CODICI O.E. ED IL LORO TESTO SONO RIPORTATI SOLO A TITOLO INDICATIVO
THE O.E. CODES AND THEIR TEXT ARE REPORTED ONLY FOR INDICATIVE PURPOSE

IMMAGINI - IMAGES

BPW-087



BPW-088



BPW-090

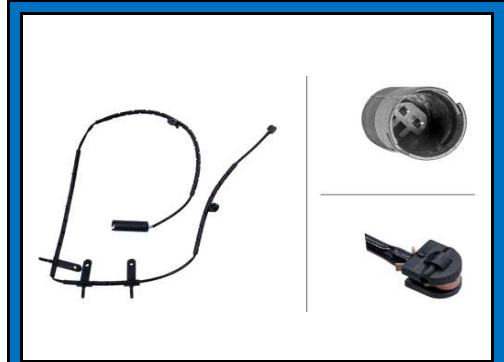

BPW-091



BPW-092



BPW-095



BPW-096

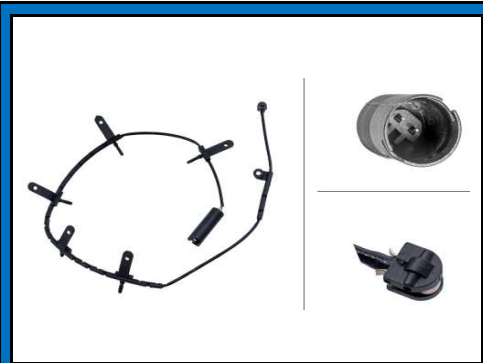

BPW-098



BPW-099



BPW-100



BPW-101



BPW-102



N.B.: I CODICI O.E. ED IL LORO TESTO SONO RIPORTATI SOLO A TITOLO INDICATIVO
THE O.E. CODES AND THEIR TEXT ARE REPORTED ONLY FOR INDICATIVE PURPOSE

IMMAGINI - IMAGES

BPW-105



BPW-106



BPW-107



BPW-108



BPW-109



BPW-111



BPW-112



BPW-113



BPW-114



BPW-117



BPW-119



BPW-124



N.B.: I CODICI O.E. ED IL LORO TESTO SONO RIPORTATI SOLO A TITOLO INDICATIVO
THE O.E. CODES AND THEIR TEXT ARE REPORTED ONLY FOR INDICATIVE PURPOSE

IMMAGINI - IMAGES

BPW-126



BPW-127



BPW-128



BPW-129

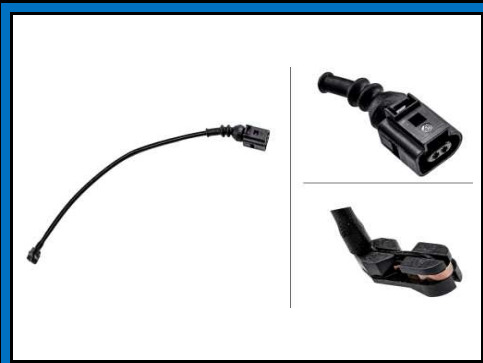

BPW-130



BPW-131



BPW-132

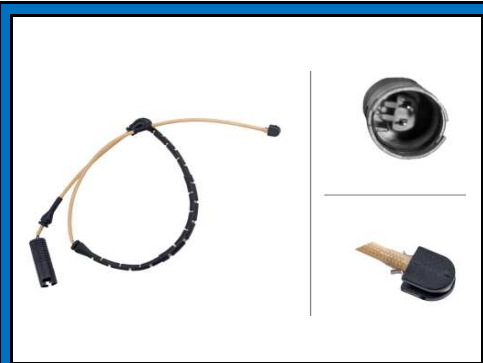

BPW-134



BPW-135



BPW-137



BPW-138



BPW-139



N.B.: I CODICI O.E. ED IL LORO TESTO SONO RIPORTATI SOLO A TITOLO INDICATIVO
 THE O.E. CODES AND THEIR TEXT ARE REPORTED ONLY FOR INDICATIVE PURPOSE

IMMAGINI - IMAGES

BPW-141

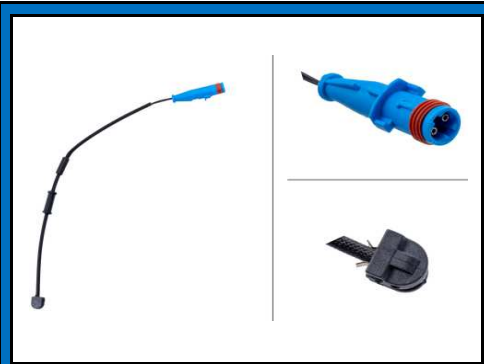

BPW-143



BPW-144



BPW-149



BPW-154



BPW-158



BPW-162



BPW-164



BPW-165



BPW-169



BPW-175



BPW-177



N.B.: I CODICI O.E. ED IL LORO TESTO SONO RIPORTATI SOLO A TITOLO INDICATIVO
THE O.E. CODES AND THEIR TEXT ARE REPORTED ONLY FOR INDICATIVE PURPOSE

IMMAGINI - IMAGES

BPW-178



BPW-179



BPW-180



BPW-181



BPW-184

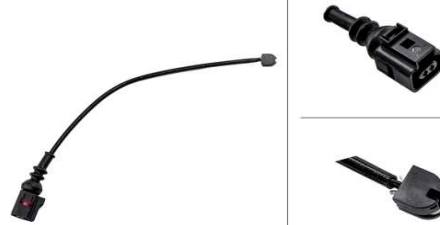

BPW-185



BPW-186



BPW-191



BPW-193



BPW-198



BPW-203

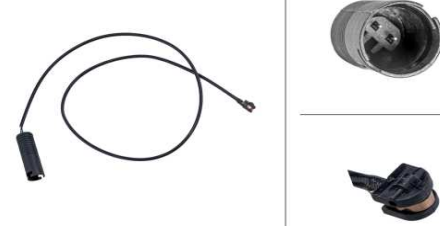

BPW-204



N.B.: I CODICI O.E. ED IL LORO TESTO SONO RIPORTATI SOLO A TITOLO INDICATIVO
THE O.E. CODES AND THEIR TEXT ARE REPORTED ONLY FOR INDICATIVE PURPOSE

IMMAGINI - IMAGES

BPW-205



BPW-206

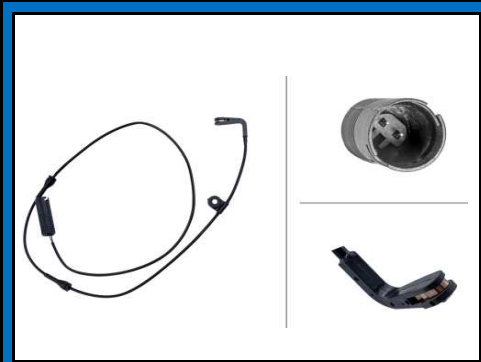

BPW-217



BPW-226



BPW-227



BPW-232



BPW-246

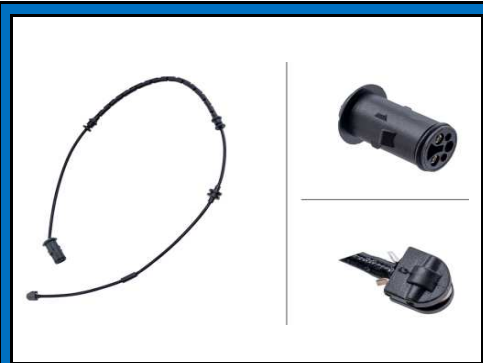

BPW-248

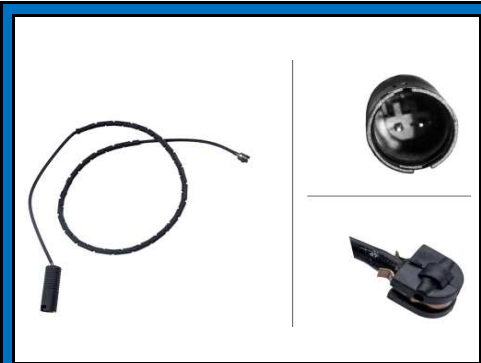

BPW-252



BPW-265



BPW-285



BPW-286



N.B.: I CODICI O.E. ED IL LORO TESTO SONO RIPORTATI SOLO A TITOLO INDICATIVO
THE O.E. CODES AND THEIR TEXT ARE REPORTED ONLY FOR INDICATIVE PURPOSE

IMMAGINI - IMAGES

BPW-287



BPW-288

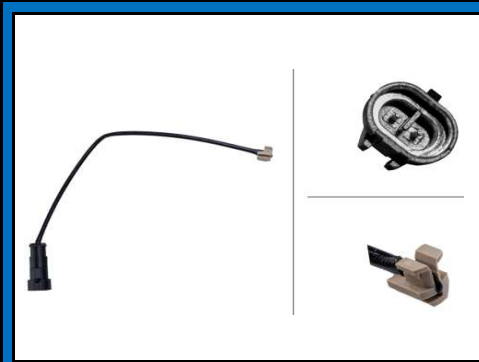

BPW-289



BPW-290



BPW-291

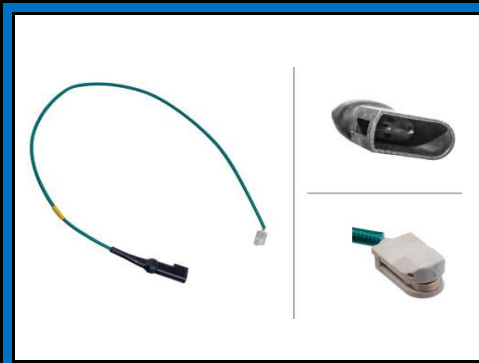

BPW-292



BPW-293



BPW-294



BPW-295



BPW-296



BPW-297



BPW-298



N.B.: I CODICI O.E. ED IL LORO TESTO SONO RIPORTATI SOLO A TITOLO INDICATIVO
THE O.E. CODES AND THEIR TEXT ARE REPORTED ONLY FOR INDICATIVE PURPOSE

IMMAGINI - IMAGES

BPW-299



BPW-300



BPW-301



BPW-302



BPW-303

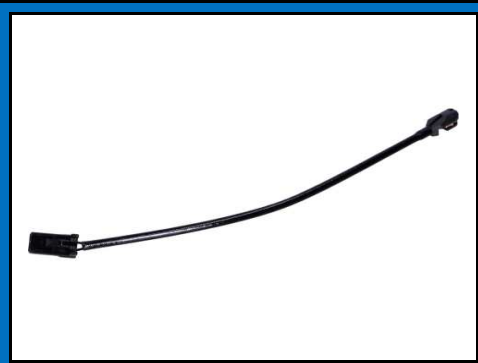

BPW-304



BPW-305



BPW-306



BPW-307



BPW-308



BPW-309

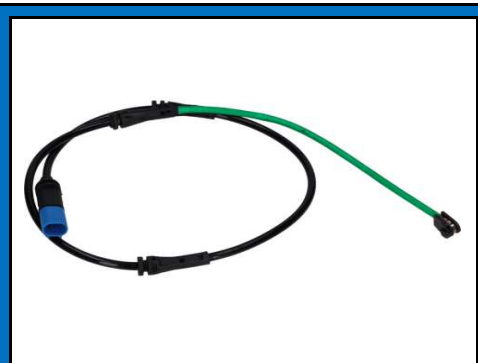

BPW-310



N.B.: I CODICI O.E. ED IL LORO TESTO SONO RIPORTATI SOLO A TITOLO INDICATIVO
THE O.E. CODES AND THEIR TEXT ARE REPORTED ONLY FOR INDICATIVE PURPOSE

IMMAGINI - IMAGES

BPW-311



BPW-312



BPW-313



BPW-314



BPW-315



BPW-317

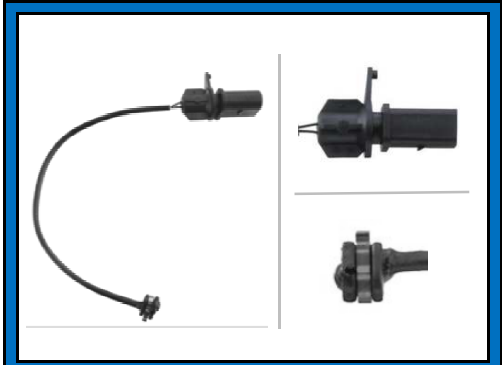

BPW-318

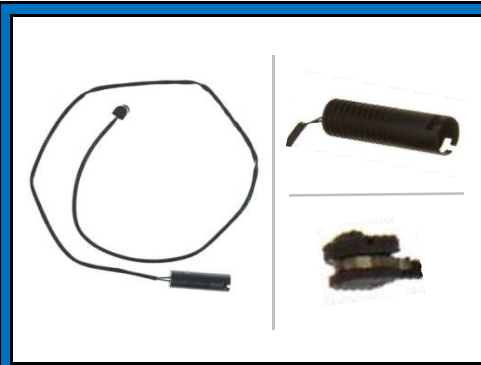

BPW-319

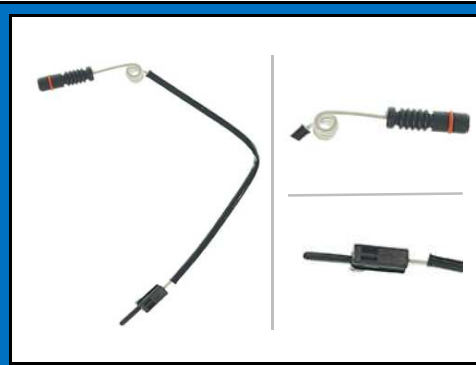

BPW-320

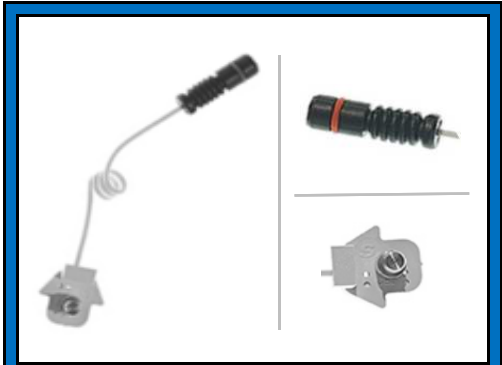

BPW-321



BPW-322



BPW-323



N.B.: I CODICI O.E. ED IL LORO TESTO SONO RIPORTATI SOLO A TITOLO INDICATIVO
 THE O.E. CODES AND THEIR TEXT ARE REPORTED ONLY FOR INDICATIVE PURPOSE

IMMAGINI - IMAGES

BPW-324



BPW-325



BPW-327



BPW-329

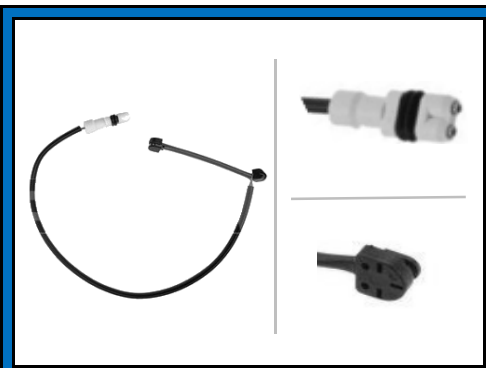

BPW-330



BPW-331



BPW-332

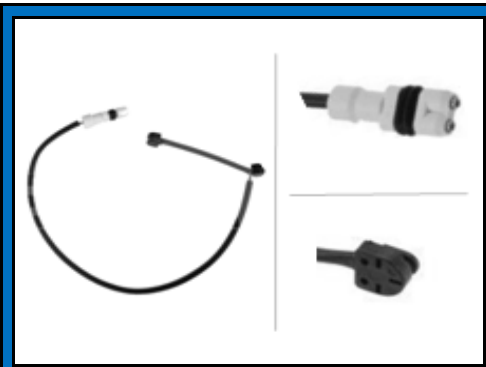

BPW-333

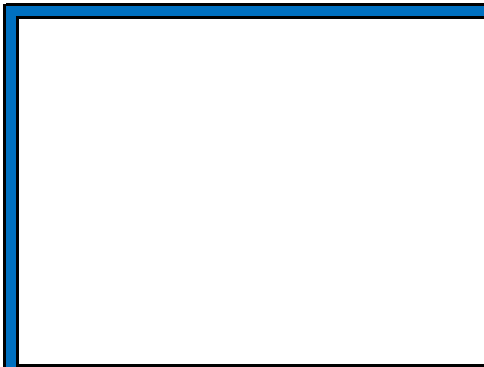
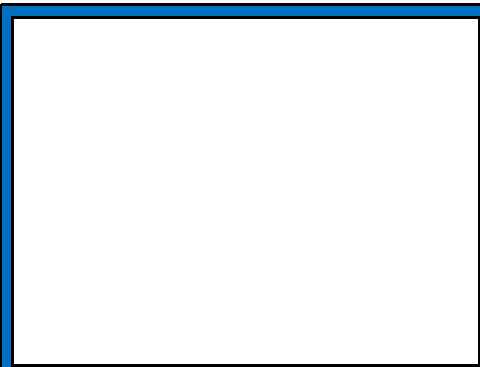
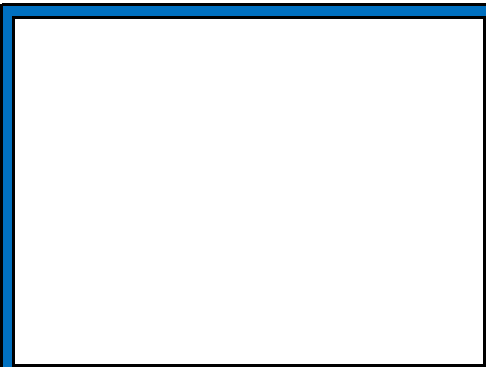
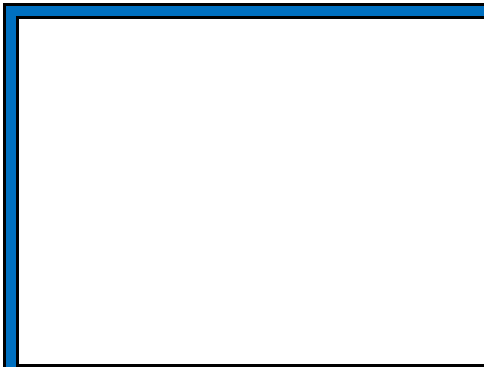
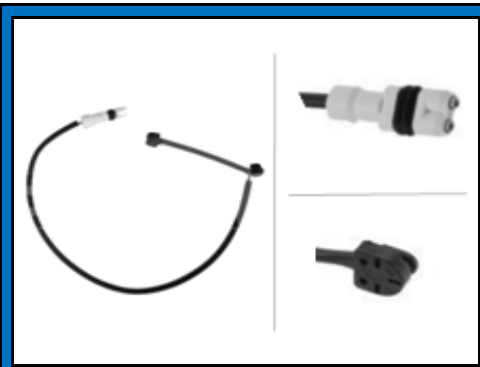

N.B.: I CODICI O.E. ED IL LORO TESTO SONO RIPORTATI SOLO A TITOLO INDICATIVO
 THE O.E. CODES AND THEIR TEXT ARE REPORTED ONLY FOR INDICATIVE PURPOSE

ABBINAMENTO PASTIGLIE
PAD MATCHING

JapKo[®]

CODICE (CODE)	CODICE PASTIGLIE FRENO (BRAKE PADS CODE)
BPW-001	500523 - 500528 - 500532 500538 - 50915 - 50920 50921 - 510515 - 510522 510528 - 510529 - 510535 510536
BPW-002	500067 - 500068 - 500069 500503 - 500504 - 500512 500513 - 500515 - 500516 500519 - 500523 - 500529 500533 - 500534 - 500544 500547 - 500549 - 510501 510504 - 510505 - 510507 510511 - 510517 - 510526 510533 - 51911
BPW-003	500510 - 500524 - 500526
BPW-004	500538 - 500539 - 510528
BPW-005	500067 - 500068 - 500069 500503 - 500504 - 500511 500512 - 500513 - 500515 500516 - 500519 - 500522 500523 - 500529 - 500533 500534 - 500544 - 500547 51911
BPW-006	500916
BPW-007	500523 - 500527 - 500528 500532 - 500539 - 500546 50915 - 50921 - 510515 510522 - 510528 - 510529 510535 - 510536
BPW-008	500103 - 500104 - 500105 500106
BPW-010	510101 - 510102 - 510121
BPW-011	510103 - 510118

CODICE (CODE)	CODICE PASTIGLIE FRENO (BRAKE PADS CODE)
BPW-012	500541 - 500553 - 510513
BPW-013	500124 - 500125 - 500126
BPW-014	500931 - 500933 - 500949
BPW-015	500107 - 500109 - 500135
BPW-016	510112 - 510113
BPW-018	510523
BPW-019	500554 - 510530
BPW-021	510915 - 510918 - 510919
BPW-022	500107 - 500128 - 502029
BPW-025	500026 - 500060 - 500505 500506 - 500508 - 500520 500530 - 510502 - 510504 510510 - 51911
BPW-026	510112 - 510113
BPW-027	510925
BPW-028	510115
BPW-029	500106
BPW-030	510112

CODICE (CODE)	CODICE PASTIGLIE FRENO (BRAKE PADS CODE)
BPW-031	500932
BPW-032	51L09
BPW-034	500049 - 500108 - 500109 500135
BPW-035	50L07
BPW-036	500933
BPW-037	500048 - 500049 - 500101 500113 - 500114
BPW-038	500132 - 500134
BPW-039	500005 - 500006
BPW-040	51L00
BPW-041	510910 - 510911 - 510929
BPW-042	500948 - 500998
BPW-043	500048 - 500115 - 500122
BPW-044	510109 - 510116 - 510117
BPW-045	500113 - 500114
BPW-047	51L01 - 51L08
BPW-049	500107 - 500128 - 502029

CODICE (CODE)	CODICE PASTIGLIE FRENO (BRAKE PADS CODE)
BPW-050	50L12
BPW-051	500925 - 500930
BPW-053	510112 - 510113
BPW-054	500413 - 500525
BPW-055	510109 - 510111
BPW-056	510008 - 510108
BPW-057	500128 - 502029
BPW-058	510109 - 510116 - 510117
BPW-059	510119
BPW-060	500132 - 500134
BPW-061	500537 - 500540 - 510512 510521
BPW-062	500048 - 500113 - 500114
BPW-065	510100
BPW-067	500108 - 500136 - 500137
BPW-068	500136
BPW-070	510313

CODICE (CODE)	CODICE PASTIGLIE FRENO (BRAKE PADS CODE)
BPW-071	51L00
BPW-073	51L00
BPW-074	510113
BPW-076	500048 - 500108
BPW-077	510119
BPW-078	500121 - 500131
BPW-079	500113
BPW-080	50L08
BPW-081	500112 - 500121
BPW-082	510115
BPW-083	500917 - 500918 - 500962 500963
BPW-084	51L00
BPW-085	500119 - 500121
BPW-086	500108 - 500136 - 500137
BPW-087	51L09
BPW-088	500048 - 500113 - 500114

CODICE (CODE)	CODICE PASTIGLIE FRENO (BRAKE PADS CODE)
BPW-090	510015
BPW-091	510313
BPW-092	500948 - 500976
BPW-095	50L14
BPW-096	500027 - 500136
BPW-098	500924
BPW-099	50L01
BPW-100	50L12
BPW-101	500998
BPW-102	510112 - 510113
BPW105	50L14
BPW-106	50L08 - 50L15
BPW-107	500231 - 500530 - 510519
BPW-108	510115
BPW-109	51L01
BPW-111	510110

CODICE (CODE)	CODICE PASTIGLIE FRENO (BRAKE PADS CODE)
BPW-112	500122
BPW-113	510109
BPW-114	510112 - 510113
BPW-117	510109 - 510111
BPW-119	500111
BPW-124	510112 - 510113
BPW-126	500005 - 510105
BPW-127	510914
BPW-128	500048 - 500113 - 500114
BPW-129	510914
BPW-130	510313
BPW-131	500111 - 500112
BPW-132	50L01 - 50L05 - 50L06 50L07
BPW-134	500132 - 500133 - 500134
BPW-135	50L14 - 510313
BPW-137	500130

CODICE (CODE)	CODICE PASTIGLIE FRENO (BRAKE PADS CODE)
BPW-138	502029
BPW-139	50L12 - 50L14
BPW-141	500074 - 50027
BPW-143	50L01 - 50L07
BPW-144	510008 - 510108
BPW-149	500925
BPW-154	500231 - 500530 - 510519
BPW-158	500132 - 500134
BPW-162	500029 - 500073 - 500404 500410 - 500412
BPW-164	510932
BPW-165	500339
BPW-169	500958
BPW-175	500409
BPW-177	5009102 - 510932 - 5009107
BPW-178	500141 - 500111 - 510106
BPW-179	500339 - 500340

CODICE (CODE)	CODICE PASTIGLIE FRENO (BRAKE PADS CODE)
BPW-180	500404
BPW-181	510104 - 510112
BPW-184	50921
BPW-185	510913
BPW-186	50L06
BPW-191	51L00
BPW-193	500931
BPW-198	500048 - 500114
BPW-203	510105
BPW-204	51L00
BPW-205	500113
BPW-206	510110
BPW-217	51L02
BPW-226	500074
BPW-227	510009
BPW-232	510112

CODICE (CODE)	CODICE PASTIGLIE FRENO (BRAKE PADS CODE)
BPW-246	500032 - 500074
BPW-248	510009
BPW-252	510216 - 510314
BPW-265	5009102 - 5009107
BPW-285	500014 - 510219
BPW-286	500013
BPW-287	510307
BPW-288	500011 - 500012 - 500233 500235 - 50161
BPW-289	500235
BPW-290	500013
BPW-291	510307
BPW-292	500410 - 50390
BPW-293	50376
BPW-294	50161
BPW-295	500517
BPW-296	500618 - 500620 - 500657

COMPARATIVA
CROSS REFERENCE

A.B.S.	CODICE (CODE)	A.B.S.	CODICE (CODE)	APEC	CODICE (CODE)	APEC	CODICE (CODE)
39444	BPW-315	39747	BPW-193	BWR5037	BPW-107	WIR5262	BPW-108
39506	BPW-330	39749	BPW-114	BWR5039	BPW-001	WIR5266	BPW-134
39514	BPW-203	39751	BPW-008	BWR5048	BPW-060	WIR5267	BPW-193
39526	BPW-178	39752	BPW-010	BWR5086	BPW-114	WIR5269	BPW-076
39535	BPW-318	39756	BPW-305	BWR5109	BPW-015	WIR5270	BPW-088
39580	BPW-320	39765	BPW-330	BWR5135	BPW-203	WIR5274	BPW-134
39583	BPW-162	39769	BPW-287	KIT100	BPW-025	WIR5281	BPW-287
39594	BPW-325	39770	BPW-315	KIT101	BPW-054	WIR5297	BPW-015
39595	BPW-154	39774	BPW-149	KIT113	BPW-126	WIR5316	BPW-185
39597	BPW-107	39777	BPW-185	KIT113	BPW-203	WIR5319	BPW-050
39601	BPW-289	39781	BPW-080	KIT114	BPW-126	WIR5323	BPW-041
39616	BPW-227	39782	BPW-032	KIT118	BPW-292	WIR5324	BPW-031
39618	BPW-246	39783	BPW-035	KIT120	BPW-294	WIR5325	BPW-083
39619	BPW-141	39797	BPW-015	KIT124	BPW-180	WIR5327	BPW-022
39625	BPW-007	39808	BPW-053	KIT125	BPW-175	WIR5328	BPW-026
39627	BPW-001	39809	BPW-049	KIT127	BPW-293	WIR5331	BPW-149
39630	BPW-047	39812	BPW-298	KIT128	BPW-085	WIR5348	BPW-100
39634	BPW-295	39813	BPW-299	KIT129	BPW-111	WIR5349	BPW-139
39640	BPW-158	39814	BPW-074	KIT131	BPW-206	WIR5350	BPW-091
39641	BPW-060	39815	BPW-057	KIT132	BPW-012	WIR5355	BPW-087
39643	BPW-099	39909	BPW-050	KIT136	BPW-248	WIR5357	BPW-106
39653	BPW-018	39911	BPW-041	KIT137	BPW-040	WIR5375	BPW-169
39660	BPW-327	39914	BPW-083	KIT138	BPW-039		
39661	BPW-329	39921	BPW-031	KIT178	BPW-107		
39664	BPW-265	39924	BPW-022	WIR5113	BPW-203		
39665	BPW-184	39925	BPW-026	WIR5139	BPW-141		
39672	BPW-296	39974	BPW-127	WIR5175	BPW-107		
39675	BPW-144	39975	BPW-129	WIR5178	BPW-007		
39676	BPW-056	39976	BPW-139	WIR5187	BPW-099		
39677	BPW-013	39978	BPW-091	WIR5190	BPW-060		
39681	BPW-205	39981	BPW-169	WIR5192	BPW-158		
39682	BPW-331	39982	BPW-124	WIR5217	BPW-184		
39684	BPW-108	39983	BPW-135	WIR5224	BPW-290		
39685	BPW-016	39985	BPW-106	WIR5228	BPW-295		
39686	BPW-134	39986	BPW-087	WIR5230	BPW-080		
39687	BPW-029			WIR5231	BPW-032		
39688	BPW-044			WIR5232	BPW-289		
39689	BPW-076			WIR5233	BPW-067		
39690	BPW-088			WIR5234	BPW-059		
39692	BPW-079			WIR5235	BPW-205		
39693	BPW-181			WIR5236	BPW-079		
39694	BPW-062			WIR5238	BPW-062		
39695	BPW-038			WIR5239	BPW-144		
39697	BPW-030			WIR5240	BPW-056		
39698	BPW-068			WIR5247	BPW-036		
39699	BPW-065			WIR5248	BPW-027		
39700	BPW-067			WIR5249	BPW-068		
39701	BPW-059			WIR5250	BPW-065		
39703	BPW-027			WIR5251	BPW-013		
39704	BPW-036			WIR5252	BPW-016		
39711	BPW-329			WIR5254	BPW-029		
39713	BPW-290			WIR5255	BPW-030		
39724	BPW-005			WIR5256	BPW-044		
39725	BPW-193			WIR5257	BPW-198		
39736	BPW-198			WIR5259	BPW-181		

N.B.: I CODICI O.E. ED IL LORO TESTO SONO RIPORTATI SOLO A TITOLO INDICATIVO
THE O.E. CODES AND THEIR TEXT ARE REPORTED ONLY FOR INDICATIVE PURPOSE

ATE	CODICE (CODE)	ATE	CODICE (CODE)	ATE	CODICE (CODE)	BENDIX	CODICE (CODE)
600929	BPW-014	620275	BPW-117	620987	BPW-022	581303	BPW-178
620005	BPW-018	620277	BPW-086	620998	BPW-287	581304	BPW-025
620006	BPW-008	620278	BPW-077	620999	BPW-315	581305	BPW-054
620007	BPW-010	620282	BPW-144	621302	BPW-306	581307	BPW-302
620011	BPW-322	620283	BPW-205	621304	BPW-288	581328	BPW-306
620012	BPW-323	620284	BPW-076	621306	BPW-047	581329	BPW-178
620024	BPW-333	620286	BPW-062	621307	BPW-186	581330	BPW-126
620025	BPW-332	620287	BPW-088	621308	BPW-204	581330	BPW-203
620067	BPW-005	620289	BPW-038	622801	BPW-325	581331	BPW-126
620106	BPW-184	620290	BPW-044	622802	BPW-248	581332	BPW-025
620107	BPW-317	620291	BPW-134	622901	BPW-294	581333	BPW-025
620206	BPW-203	620294	BPW-181			581334	BPW-301
620207	BPW-126	620295	BPW-198			581335	BPW-301
620211	BPW-318	620296	BPW-056			581341	BPW-292
620214	BPW-178	620297	BPW-079			581344	BPW-306
620215	BPW-330	620298	BPW-013			581357	BPW-071
620218	BPW-111	620312	BPW-016			581359	BPW-248
620219	BPW-085	620313	BPW-300			581361	BPW-107
620220	BPW-039	620401	BPW-025			581365	BPW-078
620221	BPW-040	620402	BPW-054			581367	BPW-131
620222	BPW-206	620407	BPW-012			581368	BPW-154
620225	BPW-078	620411	BPW-154			581370	BPW-307
620226	BPW-071	620412	BPW-107			581371	BPW-293
620227	BPW-131	620416	BPW-002			581372	BPW-206
620228	BPW-040	620417	BPW-061			581373	BPW-175
620229	BPW-227	620418	BPW-007			581376	BPW-180
620230	BPW-112	620424	BPW-004			581377	BPW-111
620231	BPW-113	620425	BPW-001			581378	BPW-040
620235	BPW-096	620701	BPW-302			581380	BPW-085
620236	BPW-090	620702	BPW-302			581385	BPW-141
620237	BPW-043	620704	BPW-301			581386	BPW-226
620238	BPW-055	620707	BPW-292			581387	BPW-227
620239	BPW-117	620710	BPW-307			581392	BPW-076
620240	BPW-081	620711	BPW-175			581401	BPW-045
620241	BPW-084	620712	BPW-301			581402	BPW-060
620242	BPW-037	620714	BPW-180			581404	BPW-001
620243	BPW-028	620715	BPW-293			581404	BPW-007
620247	BPW-128	620718	BPW-162			581410	BPW-047
620248	BPW-043	620719	BPW-226			581411	BPW-099
620249	BPW-086	620720	BPW-141			581415	BPW-158
620250	BPW-077	620811	BPW-006			581417	BPW-044
620252	BPW-060	620929	BPW-014			581426	BPW-246
620253	BPW-058	620930	BPW-021			581451	BPW-038
620254	BPW-081	620931	BPW-265			581461	BPW-027
620255	BPW-158	620932	BPW-327			581467	BPW-300
620260	BPW-331	620933	BPW-324			581471	BPW-019
620264	BPW-037	620936	BPW-193			581472	BPW-008
620266	BPW-128	620937	BPW-321			581473	BPW-088
620267	BPW-045	620938	BPW-329			581475	BPW-013
620268	BPW-060	620942	BPW-011			581476	BPW-016
620269	BPW-058	620959	BPW-019			581477	BPW-205
620270	BPW-158	620961	BPW-320			581478	BPW-079
620272	BPW-037	620975	BPW-083			581479	BPW-144
620273	BPW-043	620981	BPW-034			581480	BPW-056
620274	BPW-055	620983	BPW-015			581481	BPW-181

N.B.: I CODICI O.E. ED IL LORO TESTO SONO RIPORTATI SOLO A TITOLO INDICATIVO
THE O.E. CODES AND THEIR TEXT ARE REPORTED ONLY FOR INDICATIVE PURPOSE

BENDIX	CODICE (CODE)	BOSCH	CODICE (CODE)	BOSCH	CODICE (CODE)	BOSCH	CODICE (CODE)
581482	BPW-030	1987474903	BPW-330	1987473520	BPW-038	1987474543	BPW-323
581488	BPW-108	1987473000	BPW-081	1987473522	BPW-068	1987474545	BPW-323
581489	BPW-062	1987473001	BPW-084	1987473523	BPW-065	1987474547	BPW-030
581490	BPW-067	1987473004	BPW-227	1987473524	BPW-067	1987474549	BPW-114
581491	BPW-059	1987473005	BPW-117	1987473525	BPW-059	1987474550	BPW-008
581492	BPW-065	1987473006	BPW-001	1987473527	BPW-042	1987474551	BPW-010
581493	BPW-068	1987473011	BPW-154	1987473540	BPW-198	1987474553	BPW-005
581494	BPW-036	1987473012	BPW-014	1987473541	BPW-134	1987474554	BPW-019
581500	BPW-029	1987473013	BPW-021	1987473542	BPW-137	1987474555	BPW-329
581508	BPW-265	1987473015	BPW-096	1987473543	BPW-034	1987474562	BPW-193
587047	BPW-004	1987473016	BPW-090	1987473544	BPW-011	1987474563	BPW-321
587048	BPW-018	1987473018	BPW-246	1987473548	BPW-015	1987474564	BPW-184
581300B	BPW-119	1987473019	BPW-002	1987473549	BPW-315	1987474566	BPW-027
581301B	BPW-217	1987473022	BPW-099	1987473559	BPW-101	1987474567	BPW-036
581303B	BPW-178	1987473023	BPW-332	1987473564	BPW-032	1987474573	BPW-288
581330B	BPW-203	1987473024	BPW-333	1987473566	BPW-185	1987474575	BPW-311
581337B	BPW-252	1987473026	BPW-058	1987473567	BPW-134	1987474576	BPW-286
581349B	BPW-164	1987473027	BPW-060	1987473572	BPW-315	1987474580	BPW-301
581362B	BPW-177	1987473028	BPW-158	1987473573	BPW-287	1987474594	BPW-248
581366B	BPW-191	1987473029	BPW-327	1987473574	BPW-297	1987474595	BPW-325
581379B	BPW-003	1987473030	BPW-128	1987473575	BPW-291	1987474904	BPW-119
581383B	BPW-002	1987473032	BPW-143	1987473581	BPW-080	1987474905	BPW-217
BBI1245	BPW-305	1987473033	BPW-141	1987473582	BPW-035	1987474906	BPW-302
BBI1246	BPW-179	1987473036	BPW-007	1987473583	BPW-185	1987474907	BPW-301
		1987473037	BPW-004	1987473584	BPW-285	1987474908	BPW-301
		1987473038	BPW-018	1987473586	BPW-295	1987474909	BPW-252
		1987473040	BPW-324	1987473587	BPW-092	1987474910	BPW-178
		1987473041	BPW-265	1987473589	BPW-050	1987474913	BPW-330
		1987473043	BPW-112	1987473599	BPW-031	1987474914	BPW-119
		1987473044	BPW-113	1987473601	BPW-169	1987474916	BPW-302
		1987473045	BPW-037	1987473601	BPW-314	1987474917	BPW-301
		1987473055	BPW-109	1987473603	BPW-041	1987474918	BPW-301
		1987473058	BPW-086	1987473603	BPW-313	1987474920	BPW-178
		1987473059	BPW-077	1987473604	BPW-083	1987474923	BPW-301
		1987473060	BPW-329	1987473609	BPW-129	1987474925	BPW-126
		1987473068	BPW-321	1987473610	BPW-127	1987474926	BPW-203
		1987473069	BPW-028	1987473611	BPW-026	1987474929	BPW-292
		1987473070	BPW-003	1987473612	BPW-124	1987474933	BPW-307
		1987473500	BPW-013	1987473613	BPW-022	1987474934	BPW-175
		1987473501	BPW-082	1987473614	BPW-102	1987474936	BPW-293
		1987473504	BPW-205	1987473615	BPW-053	1987474940	BPW-111
		1987473505	BPW-144	1987473616	BPW-049	1987474942	BPW-206
		1987473506	BPW-331	1987473617	BPW-074	1987474943	BPW-039
		1987473508	BPW-108	1987473618	BPW-057	1987474944	BPW-040
		1987473509	BPW-016	1987473619	BPW-299	1987474945	BPW-078
		1987473510	BPW-134	1987473620	BPW-298	1987474946	BPW-071
		1987473511	BPW-029	1987474489	BPW-300	1987474955	BPW-191
		1987473512	BPW-044	1987474505	BPW-006	1987474956	BPW-318
		1987473513	BPW-076	1987474506	BPW-051	1987474958	BPW-085
		1987473514	BPW-088	1987474512	BPW-312	1987474960	BPW-131
		1987473515	BPW-063	1987474513	BPW-305	1987474963	BPW-320
		1987473516	BPW-079	1987474517	BPW-149	1987474964	BPW-319
		1987473517	BPW-056	1987474519	BPW-296	1987474966	BPW-003
		1987473518	BPW-181	1987474520	BPW-289	1987474969	BPW-012
		1987473519	BPW-062	1987474542	BPW-322	1987474972	BPW-180

N.B.: I CODICI O.E. ED IL LORO TESTO SONO RIPORTATI SOLO A TITOLO INDICATIVO
THE O.E. CODES AND THEIR TEXT ARE REPORTED ONLY FOR INDICATIVE PURPOSE

BOSCH	CODICE (CODE)	BREMBO	CODICE (CODE)	BREMBO	CODICE (CODE)	BREMBO	CODICE (CODE)
1987474973	BPW-162	A 00 200	BPW-085	A 00 285	BPW-107	A 00 447	BPW-059
1987474994	BPW-164	A 00 201	BPW-111	A 00 286	BPW-001	A 00 451	BPW-042
1987474997	BPW-177	A 00 206	BPW-014	A 00 287	BPW-004	A 00 452	BPW-027
1987474999	BPW-325	A 00 207	BPW-021	A 00 288	BPW-018	A 00 453	BPW-036
		A 00 209	BPW-184	A 00 291	BPW-007	A 00 455	BPW-030
		A 00 211	BPW-037	A 00 294	BPW-325	A 00 460	BPW-305
		A 00 212	BPW-028	A 00 295	BPW-248	A 00 466	BPW-149
		A 00 213	BPW-045	A 00 296	BPW-096	A 00 467	BPW-051
		A 00 214	BPW-330	A 00 297	BPW-090	A 00 468	BPW-051
		A 00 215	BPW-119	A 00 298	BPW-077	A 00 469	BPW-179
		A 00 216	BPW-217	A 00 299	BPW-086	A 00 470	BPW-295
		A 00 217	BPW-126	A 00 300	BPW-302	A 00 471	BPW-002
		A 00 218	BPW-203	A 00 308	BPW-307	A 00 472	BPW-114
		A 00 220	BPW-039	A 00 309	BPW-175	A 00 473	BPW-008
		A 00 221	BPW-040	A 00 310	BPW-301	A 00 474	BPW-010
		A 00 222	BPW-131	A 00 333	BPW-177	A 00 478	BPW-080
		A 00 223	BPW-128	A 00 336	BPW-329	A 00 479	BPW-032
		A 00 224	BPW-318	A 00 337	BPW-324	A 00 481	BPW-297
		A 00 226	BPW-178	A 00 338	BPW-265	A 00 482	BPW-098
		A 00 228	BPW-043	A 00 341	BPW-164	A 00 483	BPW-019
		A 00 229	BPW-055	A 00 342	BPW-327	A 00 484	BPW-006
		A 00 230	BPW-206	A 00 345	BPW-193	A 00 487	BPW-198
		A 00 231	BPW-117	A 00 346	BPW-021	A 00 494	BPW-185
		A 00 233	BPW-191	A 00 346	BPW-321	A 00 498	BPW-035
		A 00 236	BPW-112	A 00 347	BPW-317	A 00 499	BPW-101
		A 00 237	BPW-113	A 00 350	BPW-025	A 00 499	BPW-092
		A 00 240	BPW-081	A 00 351	BPW-288	A 00 503	BPW-315
		A 00 241	BPW-084	A 00 353	BPW-005	A 00 504	BPW-291
		A 00 243	BPW-078	A 00 355	BPW-320	A 00 505	BPW-287
		A 00 244	BPW-071	A 00 377	BPW-019	A 00 506	BPW-015
		A 00 245	BPW-060	A 00 377	BPW-003	A 00 507	BPW-011
		A 00 246	BPW-158	A 00 408	BPW-285	A 00 509	BPW-034
		A 00 247	BPW-058	A 00 410	BPW-290	A 00 516	BPW-178
		A 00 248	BPW-227	A 00 422	BPW-013	A 00 518	BPW-310
		A 00 251	BPW-226	A 00 423	BPW-082	A 00 525	BPW-073
		A 00 254	BPW-246	A 00 425	BPW-232	A 00 532	BPW-070
		A 00 255	BPW-141	A 00 426	BPW-205	A 00 533	BPW-091
		A 00 258	BPW-306	A 00 427	BPW-144	A 00 557	BPW-138
		A 00 260	BPW-252	A 00 428	BPW-331	A 00 585	BPW-308
		A 00 262	BPW-292	A 00 430	BPW-108	A00214	BPW-330
		A 00 263	BPW-293	A 00 431	BPW-016	A00224	BPW-318
		A 00 264	BPW-180	A 00 432	BPW-134	A00283	BPW-319
		A 00 265	BPW-047	A 00 433	BPW-029	A00294	BPW-325
		A 00 266	BPW-047	A 00 434	BPW-044	A00334	BPW-332
		A 00 267	BPW-047	A 00 435	BPW-076	A00335	BPW-333
		A 00 267	BPW-143	A 00 436	BPW-088	A00336	BPW-329
		A 00 268	BPW-132	A 00 437	BPW-063	A00337	BPW-324
		A 00 271	BPW-109	A 00 438	BPW-079	A00342	BPW-327
		A 00 273	BPW-099	A 00 439	BPW-056	A00346	BPW-321
		A 00 274	BPW-003	A 00 440	BPW-181	A00347	BPW-317
		A 00 275	BPW-054	A 00 441	BPW-062	A00355	BPW-320
		A 00 279	BPW-002	A 00 442	BPW-038	A00406	BPW-332
		A 00 282	BPW-012	A 00 444	BPW-068	A00406	BPW-333
		A 00 283	BPW-319	A 00 445	BPW-065	A00428	BPW-331
		A 00 284	BPW-154	A 00 446	BPW-067	A00503	BPW-315

N.B.: I CODICI O.E. ED IL LORO TESTO SONO RIPORTATI SOLO A TITOLO INDICATIVO
THE O.E. CODES AND THEIR TEXT ARE REPORTED ONLY FOR INDICATIVE PURPOSE

BREMSI	CODICE (CODE)	BREMSI	CODICE (CODE)	BREMSI	CODICE (CODE)	BREMSI	CODICE (CODE)
WI0401	BPW-015	WI0616	BPW-227	WI0728	BPW-179	WI0986	BPW-087
WI0403	BPW-102	WI0617	BPW-117	WI0734	BPW-300		
WI0404	BPW-138	WI0618	BPW-246	WI0736	BPW-198		
WI0414	BPW-105	WI0619	BPW-141	WI0747	BPW-193		
WI0415	BPW-165	WI0621	BPW-204	WI0749	BPW-114		
WI0444	BPW-315	WI0623	BPW-132	WI0751	BPW-008		
WI0476	BPW-309	WI0625	BPW-007	WI0752	BPW-010		
WI0501	BPW-025	WI0627	BPW-001	WI0756	BPW-305		
WI0502	BPW-119	WI0630	BPW-047	WI0762	BPW-143		
WI0505	BPW-217	WI0631	BPW-004	WI0768	BPW-019		
WI0507	BPW-054	WI0634	BPW-295	WI0769	BPW-287		
WI0510	BPW-302	WI0635	BPW-128	WI0770	BPW-315		
WI0514	BPW-203	WI0637	BPW-045	WI0771	BPW-312		
WI0515	BPW-126	WI0639	BPW-058	WI0774	BPW-149		
WI0517	BPW-301	WI0640	BPW-158	WI0777	BPW-185		
WI0518	BPW-301	WI0641	BPW-060	WI0781	BPW-080		
WI0521	BPW-252	WI0643	BPW-099	WI0782	BPW-032		
WI0526	BPW-178	WI0644	BPW-109	WI0783	BPW-035		
WI0527	BPW-292	WI0645	BPW-086	WI0788	BPW-044		
WI0531	BPW-191	WI0646	BPW-077	WI0798	BPW-297		
WI0532	BPW-175	WI0653	BPW-018	WI0800	BPW-291		
WI0534	BPW-111	WI0664	BPW-265	WI0801	BPW-034		
WI0557	BPW-307	WI0665	BPW-184	WI0808	BPW-053		
WI0559	BPW-180	WI0672	BPW-296	WI0809	BPW-049		
WI0560	BPW-293	WI0675	BPW-144	WI0812	BPW-298		
WI0565	BPW-012	WI0676	BPW-056	WI0813	BPW-299		
WI0566	BPW-085	WI0677	BPW-013	WI0814	BPW-074		
WI0572	BPW-306	WI0678	BPW-082	WI0815	BPW-057		
WI0576	BPW-177	WI0680	BPW-232	WI0816	BPW-011		
WI0577	BPW-164	WI0681	BPW-205	WI0902	BPW-288		
WI0578	BPW-206	WI0684	BPW-108	WI0904	BPW-294		
WI0581	BPW-039	WI0685	BPW-016	WI0906	BPW-070		
WI0582	BPW-040	WI0686	BPW-134	WI0909	BPW-050		
WI0583	BPW-162	WI0687	BPW-029	WI0913	BPW-041		
WI0584	BPW-078	WI0689	BPW-076	WI0914	BPW-083		
WI0585	BPW-071	WI0690	BPW-088	WI0915	BPW-137		
WI0587	BPW-131	WI0691	BPW-063	WI0918	BPW-073		
WI0590	BPW-002	WI0692	BPW-079	WI0921	BPW-031		
WI0593	BPW-248	WI0693	BPW-181	WI0922	BPW-101		
WI0595	BPW-154	WI0694	BPW-062	WI0924	BPW-022		
WI0597	BPW-107	WI0695	BPW-038	WI0925	BPW-026		
WI0601	BPW-289	WI0697	BPW-030	WI0932	BPW-130		
WI0602	BPW-043	WI0698	BPW-068	WI0935	BPW-092		
WI0603	BPW-055	WI0699	BPW-065	WI0973	BPW-314		
WI0604	BPW-226	WI0700	BPW-067	WI0974	BPW-127		
WI0606	BPW-096	WI0701	BPW-059	WI0975	BPW-129		
WI0607	BPW-090	WI0702	BPW-042	WI0976	BPW-100		
WI0608	BPW-112	WI0703	BPW-027	WI0977	BPW-139		
WI0609	BPW-113	WI0704	BPW-036	WI0978	BPW-091		
WI0610	BPW-081	WI0713	BPW-290	WI0979	BPW-308		
WI0611	BPW-084	WI0714	BPW-285	WI0981	BPW-169		
WI0612	BPW-037	WI0715	BPW-286	WI0982	BPW-124		
WI0613	BPW-028	WI0723	BPW-006	WI0983	BPW-135		
WI0614	BPW-014	WI0724	BPW-005	WI0984	BPW-095		
WI0615	BPW-021	WI0727	BPW-051	WI0985	BPW-106		

N.B.: I CODICI O.E. ED IL LORO TESTO SONO RIPORTATI SOLO A TITOLO INDICATIVO
THE O.E. CODES AND THEIR TEXT ARE REPORTED ONLY FOR INDICATIVE PURPOSE

CIFAM	CODICE (CODE)	CIFAM	CODICE (CODE)	CIFAM	CODICE (CODE)	DELPHI	CODICE (CODE)
SU.011	BPW-025	SU.221	BPW-134	SU.318	BPW-162	LZ0008	BPW-119
SU.012	BPW-054	SU.222	BPW-086	SU.319	BPW-246	LZ0010	BPW-217
SU.072	BPW-217	SU.223	BPW-077	SU.320	BPW-141	LZ0013	BPW-252
SU.082	BPW-252	SU.224	BPW-006	SU.321	BPW-179	LZ0101	BPW-330
SU.083	BPW-126	SU.225K	BPW-285	SU.322	BPW-305	LZ0108	BPW-119
SU.083	BPW-203	SU.226K	BPW-289	SU.324	BPW-067	LZ0109	BPW-178
SU.088	BPW-306	SU.227K	BPW-290	SU.325	BPW-059	LZ0113	BPW-252
SU.090	BPW-301	SU.229	BPW-047	SU.329	BPW-287	LZ0119	BPW-203
SU.091	BPW-302	SU.242	BPW-296	SU.330	BPW-019	LZ0135	BPW-318
SU.092	BPW-111	SU.246	BPW-184	SU.331	BPW-092	LZ0140	BPW-191
SU.093	BPW-293	SU.253	BPW-143	SU.332	BPW-101	LZ0152	BPW-162
SU.099	BPW-012	SU.255	BPW-099	SU.338	BPW-015	LZ0153	BPW-003
SU.100K	BPW-288	SU.256	BPW-186	SU.340	BPW-297	LZ0155	BPW-325
SU.101K	BPW-294	SU.259	BPW-128	SU.341	BPW-291	LZ0162	BPW-002
SU.104	BPW-085	SU.260K	BPW-311	SU.345	BPW-083	LZ0178	BPW-205
SU.108	BPW-292	SU.264	BPW-265	SU.346	BPW-313	LZ0182	BPW-227
SU.112	BPW-039	SU.265	BPW-164	SU.347	BPW-031	LZ0185	BPW-007
SU.113	BPW-040	SU.271	BPW-036	SU.348	BPW-041	LZ0188	BPW-141
SU.123	BPW-248	SU.274	BPW-027	SU.349	BPW-310	LZ0190	BPW-004
SU.129	BPW-002	SU.275	BPW-108	SU.350	BPW-022	LZ0192	BPW-062
SU.129	BPW-005	SU.276	BPW-082	SU.351	BPW-026	LZ0194	BPW-047
SU.129	BPW-003	SU.278	BPW-008	SU.352	BPW-070	LZ0196	BPW-109
SU.142	BPW-180	SU.279	BPW-010	SU.353	BPW-050	LZ0198	BPW-099
SU.143	BPW-307	SU.280	BPW-029	SU.357	BPW-130	LZ0199	BPW-018
SU.144	BPW-175	SU.281	BPW-065	SU.361	BPW-049	LZ0205	BPW-193
SU.145	BPW-226	SU.282	BPW-068	SU.362	BPW-053	LZ0207	BPW-158
SU.147	BPW-131	SU.284	BPW-013	SU.364	BPW-127	LZ0211	BPW-013
SU.148	BPW-206	SU.287	BPW-016	SU.365	BPW-129	LZ0212	BPW-108
SU.149	BPW-096	SU.288	BPW-030	SU.366	BPW-124	LZ0213	BPW-082
SU.150	BPW-043	SU.289	BPW-312	SU.368	BPW-114	LZ0215	BPW-079
SU.151	BPW-112	SU.290	BPW-051	SU.372	BPW-299	LZ0216	BPW-144
SU.152	BPW-078	SU.291	BPW-300	SU.373	BPW-074	LZ0217	BPW-056
SU.153	BPW-132	SU.294	BPW-193	SU.374	BPW-057	LZ0218	BPW-038
SU.155	BPW-071	SU.295	BPW-098	SU.376	BPW-138	LZ0219	BPW-134
SU.156	BPW-204	SU.296	BPW-227	SU.377	BPW-102	LZ0222	BPW-198
SU.157	BPW-055	SU.297	BPW-205	SU.379	BPW-298	LZ0223	BPW-232
SU.158	BPW-113	SU.298	BPW-079	SU.380	BPW-314	LZ0224	BPW-181
SU.161	BPW-107	SU.299	BPW-062	SU.383	BPW-091	LZ0230	BPW-107
SU.161	BPW-154	SU.300	BPW-144	SU.384	BPW-139	LZ0231	BPW-319
SU.164	BPW-001	SU.301	BPW-056	SU.385	BPW-100	LZ0232	BPW-154
SU.164	BPW-007	SU.302	BPW-088	SU.387	BPW-135	LZ0235	BPW-029
SU.189	BPW-090	SU.303	BPW-063	SU.388	BPW-087	LZ0236	BPW-030
SU.195	BPW-081	SU.304	BPW-076	SU.389	BPW-106	LZ0237	BPW-016
SU.196	BPW-084	SU.305	BPW-045	SU.390	BPW-105	LZ0238	BPW-114
SU.204K	BPW-286	SU.307	BPW-198	SU.391	BPW-165	LZ0239	BPW-008
SU.205	BPW-037	SU.308	BPW-181	SU.392	BPW-073	LZ0240	BPW-010
SU.206	BPW-028	SU.309	BPW-038	SU.396	BPW-308	LZ0241	BPW-067
SU.207	BPW-117	SU.310	BPW-044	SU.398	BPW-295	LZ0242	BPW-059
SU.209	BPW-061	SU.311	BPW-034	SU.400	BPW-095	LZ0243	BPW-068
SU.217	BPW-014	SU.312	BPW-011	SU.406	BPW-309	LZ0244	BPW-065
SU.218	BPW-021	SU.313	BPW-004	SU.412	BPW-304	LZ0247	BPW-044
SU.219	BPW-177	SU.314	BPW-018	SU.413	BPW-303	LZ0248	BPW-036
SU.220	BPW-060	SU.315	BPW-035			LZ0249	BPW-027
SU.220	BPW-158	SU.316	BPW-080			LZ0250	BPW-300
SU.221	BPW-058	SU.317	BPW-032			LZ0252	BPW-305

N.B.: I CODICI O.E. ED IL LORO TESTO SONO RIPORTATI SOLO A TITOLO INDICATIVO
THE O.E. CODES AND THEIR TEXT ARE REPORTED ONLY FOR INDICATIVE PURPOSE

DELPHI	CODICE (CODE)	FEBI	CODICE (CODE)	FEBI	CODICE (CODE)	FEBI	CODICE (CODE)
LZ0254	BPW-179	02398	BPW-178	29546	BPW-018	39139	BPW-010
LZ0256	BPW-290	02917	BPW-307	29661	BPW-058	39141	BPW-114
LZ0263	BPW-329	02918	BPW-293	29662	BPW-128	39246	BPW-005
LZ0264	BPW-265	05109	BPW-292	29911	BPW-323	39247	BPW-019
LZ0264	BPW-324	05110	BPW-252	30611	BPW-158	43485	BPW-006
LZ0269	BPW-327	06860	BPW-126	30612	BPW-060	44352	BPW-323
LZ0273	BPW-315	06867	BPW-203	30613	BPW-045	44358	BPW-178
LZ0276	BPW-015	07736	BPW-119	31011	BPW-184	44479	BPW-312
LZ0300	BPW-322	07737	BPW-330	31410	BPW-317	45231	BPW-300
LZ0301	BPW-323	07835	BPW-012	31562	BPW-086	45232	BPW-149
LZ0314	BPW-073	07849	BPW-191	31563	BPW-077	47367	BPW-101
LZ0318	BPW-070	07880	BPW-054	31820	BPW-143	47368	BPW-092
LZ0330	BPW-007	08045	BPW-217	31821	BPW-099	47371	BPW-080
LZ0336	BPW-331	08197	BPW-111	31822	BPW-109	47372	BPW-032
LZ0342	BPW-134	08203	BPW-085	31823	BPW-047	47373	BPW-035
LZ0350	BPW-095	08233	BPW-318	33400	BPW-327	47375	BPW-305
LZ0357	BPW-169	11935	BPW-040	33402	BPW-333	48916	BPW-322
LZ0361	BPW-185	11936	BPW-039	33406	BPW-265	100352	BPW-025
LZ0375	BPW-138	11941	BPW-180	33407	BPW-324	100996	BPW-297
		15049	BPW-288	33408	BPW-177	100997	BPW-291
		17204	BPW-175	33410	BPW-164	101071	BPW-034
		17489	BPW-162	33994	BPW-329	101072	BPW-015
		17952	BPW-131	34072	BPW-332	102245	BPW-315
		17965	BPW-325	34497	BPW-042	102261	BPW-287
		17967	BPW-248	34498	BPW-027	102262	BPW-011
		18559	BPW-078	34499	BPW-036	104575	BPW-022
		18560	BPW-071	35447	BPW-289	104576	BPW-026
		19186	BPW-003	35448	BPW-311	104599	BPW-134
		21072	BPW-206	35450	BPW-290	104918	BPW-070
		22072	BPW-226	35493	BPW-285	104919	BPW-041
		22396	BPW-090	36426	BPW-013	104919	BPW-313
		22397	BPW-096	36427	BPW-082	104920	BPW-314
		22401	BPW-320	36428	BPW-108	106209	BPW-286
		22402	BPW-319	36429	BPW-016	170746	BPW-053
		22577	BPW-107	36570	BPW-068	170747	BPW-049
		22577	BPW-154	36571	BPW-065	170748	BPW-031
		22663	BPW-001	37158	BPW-044	170793	BPW-050
		23021	BPW-043	37256	BPW-038	171446	BPW-057
		23025	BPW-055	37437	BPW-029	171448	BPW-074
		23121	BPW-112	37454	BPW-181	172460	BPW-296
		23123	BPW-113	37458	BPW-198	172511	BPW-129
		23360	BPW-014	37662	BPW-076	172593	BPW-073
		23362	BPW-021	37664	BPW-088	172595	BPW-127
		23857	BPW-002	37665	BPW-062	172598	BPW-083
		23908	BPW-117	37667	BPW-056	172607	BPW-100
		23951	BPW-081	37668	BPW-079	173560	BPW-299
		24012	BPW-084	37669	BPW-063	173568	BPW-298
		24013	BPW-227	37727	BPW-030	176452	BPW-124
		24319	BPW-028	37728	BPW-067	179227	BPW-135
		24320	BPW-037	38173	BPW-232	180131	BPW-091
		24505	BPW-246	38174	BPW-059	197401	BPW-309
		26370	BPW-295	38575	BPW-331		
		27183	BPW-141	38578	BPW-144		
		28139	BPW-007	38642	BPW-205		
		29414	BPW-004	39138	BPW-008		

N.B.: I CODICI O.E. ED IL LORO TESTO SONO RIPORTATI SOLO A TITOLO INDICATIVO
THE O.E. CODES AND THEIR TEXT ARE REPORTED ONLY FOR INDICATIVE PURPOSE

FERODO	CODICE (CODE)	FERODO	CODICE (CODE)	FERODO	CODICE (CODE)	FERODO	CODICE (CODE)
FAI102	BPW-025	FWI271	BPW-090	FWI350	BPW-143	FWI452	BPW-313
FAI106	BPW-294	FWI272	BPW-226	FWI353	BPW-198	FWI453	BPW-083
FAI115	BPW-288	FWI273	BPW-014	FWI354	BPW-134	FWI454	BPW-101
FAI119	BPW-294	FWI274	BPW-021	FWI355	BPW-044	FWI457	BPW-080
FWI201	BPW-119	FWI275	BPW-113	FWI356	BPW-181	FWI458	BPW-032
FWI202	BPW-178	FWI276	BPW-112	FWI357	BPW-063	FWI459	BPW-035
FWI203	BPW-330	FWI277	BPW-055	FWI358	BPW-076	FWI460	BPW-050
FWI204	BPW-217	FWI278	BPW-061	FWI359	BPW-079	FWI463	BPW-031
FWI205	BPW-126	FWI279	BPW-132	FWI361	BPW-088	FWI464	BPW-127
FWI206	BPW-025	FWI280	BPW-204	FWI362	BPW-062	FWI465	BPW-129
FWI207	BPW-054	FWI282	BPW-047	FWI363	BPW-056		
FWI208	BPW-301	FWI283	BPW-131	FWI365	BPW-067		
FWI209	BPW-252	FWI284	BPW-325	FWI366	BPW-154		
FWI211	BPW-292	FWI285	BPW-248	FWI371	BPW-043		
FWI212	BPW-302	FWI286	BPW-227	FWI372	BPW-045		
FWI213	BPW-178	FWI289	BPW-141	FWI374	BPW-082		
FWI223	BPW-301	FWI289	BPW-149	FWI375	BPW-108		
FWI226	BPW-025	FWI291	BPW-117	FWI376	BPW-038		
FWI226/1	BPW-025	FWI292	BPW-081	FWI377	BPW-059		
FWI226/4	BPW-025	FWI293	BPW-018	FWI380	BPW-327		
FWI227	BPW-025	FWI294	BPW-004	FWI381	BPW-329		
FWI228	BPW-330	FWI295	BPW-040	FWI391	BPW-184		
FWI232	BPW-126	FWI296	BPW-001	FWI393	BPW-317		
FWI232	BPW-203	FWI297	BPW-186	FWI394	BPW-322		
FWI233	BPW-119	FWI298	BPW-099	FWI398	BPW-305		
FWI236	BPW-178	FWI299	BPW-290	FWI399	BPW-179		
FWI242	BPW-307	FWI300	BPW-246	FWI401	BPW-068		
FWI243	BPW-175	FWI301	BPW-084	FWI402	BPW-065		
FWI246	BPW-012	FWI303	BPW-285	FWI406	BPW-027		
FWI250	BPW-180	FWI304	BPW-286	FWI407	BPW-149		
FWI251	BPW-293	FWI305	BPW-286	FWI408	BPW-098		
FWI252	BPW-085	FWI306	BPW-289	FWI410	BPW-019		
FWI253	BPW-111	FWI308	BPW-295	FWI411	BPW-008		
FWI254	BPW-318	FWI309	BPW-077	FWI412	BPW-016		
FWI255	BPW-164	FWI310	BPW-296	FWI413	BPW-205		
FWI256	BPW-177	FWI311	BPW-007	FWI414	BPW-144		
FWI257	BPW-162	FWI312	BPW-321	FWI415	BPW-030		
FWI258	BPW-039	FWI314	BPW-306	FWI416	BPW-036		
FWI259	BPW-040	FWI315	BPW-109	FWI418	BPW-029		
FWI260	BPW-206	FWI316	BPW-086	FWI419	BPW-185		
FWI261	BPW-003	FWI317	BPW-158	FWI420	BPW-324		
FWI261	BPW-005	FWI318	BPW-060	FWI421	BPW-287		
FWI261/1	BPW-002	FWI320	BPW-045	FWI422	BPW-297		
FWI2611	BPW-003	FWI321	BPW-058	FWI423	BPW-291		
FWI262	BPW-191	FWI326	BPW-319	FWI435	BPW-114		
FWI263	BPW-043	FWI328	BPW-117	FWI436	BPW-010		
FWI264	BPW-078	FWI329	BPW-331	FWI438	BPW-034		
FWI265	BPW-071	FWI331	BPW-128	FWI442	BPW-059		
FWI266	BPW-002	FWI332	BPW-077	FWI443	BPW-015		
FWI2661	BPW-002	FWI333	BPW-232	FWI444	BPW-014		
FWI267	BPW-107	FWI334	BPW-013	FWI448	BPW-016		
FWI267	BPW-154	FWI335	BPW-038	FWI448	BPW-026		
FWI268	BPW-028	FWI340	BPW-321	FWI449	BPW-011		
FWI269	BPW-037	FWI345	BPW-265	FWI451	BPW-098		
FWI270	BPW-096	FWI347	BPW-193	FWI452	BPW-041		

N.B.: I CODICI O.E. ED IL LORO TESTO SONO RIPORTATI SOLO A TITOLO INDICATIVO
THE O.E. CODES AND THEIR TEXT ARE REPORTED ONLY FOR INDICATIVE PURPOSE

FRI.TECH.	CODICE (CODE)	FRI.TECH.	CODICE (CODE)	FRI.TECH.	CODICE (CODE)	GALFER	CODICE (CODE)
SU.011	BPW-025	SU.221	BPW-134	SU.318	BPW-162	25002	BPW-126
SU.012	BPW-054	SU.222	BPW-086	SU.319	BPW-246	25008	BPW-085
SU.072	BPW-217	SU.223	BPW-077	SU.320	BPW-141	25009	BPW-039
SU.082	BPW-252	SU.224	BPW-006	SU.321	BPW-179	25010	BPW-126
SU.083	BPW-126	SU.225K	BPW-285	SU.322	BPW-305	25012	BPW-126
SU.083	BPW-203	SU.226K	BPW-289	SU.324	BPW-067	25013	BPW-111
SU.088	BPW-306	SU.227K	BPW-290	SU.325	BPW-059	25014	BPW-040
SU.090	BPW-301	SU.229	BPW-047	SU.329	BPW-287	25015	BPW-206
SU.091	BPW-302	SU.242	BPW-296	SU.330	BPW-019	25016	BPW-131
SU.092	BPW-111	SU.246	BPW-184	SU.331	BPW-092	25017	BPW-071
SU.093	BPW-293	SU.253	BPW-143	SU.332	BPW-101	25018	BPW-078
SU.099	BPW-012	SU.255	BPW-099	SU.338	BPW-015	25021	BPW-040
SU.100K	BPW-288	SU.256	BPW-186	SU.340	BPW-297	25022	BPW-084
SU.101K	BPW-294	SU.259	BPW-128	SU.341	BPW-291	25024	BPW-112
SU.104	BPW-085	SU.260K	BPW-311	SU.345	BPW-083	25025	BPW-113
SU.108	BPW-292	SU.264	BPW-265	SU.346	BPW-313	25026	BPW-028
SU.112	BPW-039	SU.265	BPW-164	SU.347	BPW-031	25027	BPW-037
SU.113	BPW-040	SU.271	BPW-036	SU.348	BPW-041	25028	BPW-055
SU.123	BPW-248	SU.274	BPW-027	SU.349	BPW-310	25029	BPW-043
SU.129	BPW-002	SU.275	BPW-108	SU.350	BPW-022	25030	BPW-025
SU.129	BPW-005	SU.276	BPW-082	SU.351	BPW-026	25031	BPW-054
SU.129	BPW-003	SU.278	BPW-008	SU.352	BPW-070	25036	BPW-012
SU.142	BPW-180	SU.279	BPW-010	SU.353	BPW-050	25038	BPW-061
SU.143	BPW-307	SU.280	BPW-029	SU.357	BPW-130	25056	BPW-292
SU.144	BPW-175	SU.281	BPW-065	SU.361	BPW-049	25060	BPW-175
SU.145	BPW-226	SU.282	BPW-068	SU.362	BPW-053	25063	BPW-180
SU.147	BPW-131	SU.284	BPW-013	SU.364	BPW-127	25064	BPW-293
SU.148	BPW-206	SU.287	BPW-016	SU.365	BPW-129	25067	BPW-226
SU.149	BPW-096	SU.288	BPW-030	SU.366	BPW-124	25150	BPW-288
SU.150	BPW-043	SU.289	BPW-312	SU.368	BPW-114	25151	BPW-294
SU.151	BPW-112	SU.290	BPW-051	SU.372	BPW-299	25162	BPW-248
SU.152	BPW-078	SU.291	BPW-300	SU.373	BPW-074	25166	BPW-132
SU.153	BPW-132	SU.294	BPW-193	SU.374	BPW-057	25167	BPW-204
SU.155	BPW-071	SU.295	BPW-098	SU.376	BPW-138	25170	BPW-096
SU.156	BPW-204	SU.296	BPW-227	SU.377	BPW-102	25171	BPW-077
SU.157	BPW-055	SU.297	BPW-205	SU.379	BPW-298	900003	BPW-028
SU.158	BPW-113	SU.298	BPW-079	SU.380	BPW-314	900016	BPW-288
SU.161	BPW-107	SU.299	BPW-062	SU.383	BPW-091	900032	BPW-081
SU.161	BPW-154	SU.300	BPW-144	SU.384	BPW-139	900085	BPW-065
SU.164	BPW-001	SU.301	BPW-056	SU.385	BPW-100	900088	BPW-006
SU.164	BPW-007	SU.302	BPW-088	SU.387	BPW-135	900089	BPW-029
SU.189	BPW-090	SU.303	BPW-063	SU.388	BPW-087	900090	BPW-030
SU.195	BPW-081	SU.304	BPW-076	SU.389	BPW-106	900109	BPW-008
SU.196	BPW-084	SU.305	BPW-045	SU.390	BPW-105	900110	BPW-098
SU.204K	BPW-286	SU.307	BPW-198	SU.391	BPW-165	900113	BPW-010
SU.205	BPW-037	SU.308	BPW-181	SU.392	BPW-073	900124	BPW-034
SU.206	BPW-028	SU.309	BPW-038	SU.396	BPW-308	900125	BPW-011
SU.207	BPW-117	SU.310	BPW-044	SU.398	BPW-295	B1G19000072	BPW-003
SU.209	BPW-061	SU.311	BPW-034	SU.400	BPW-095	B1G19000172	BPW-217
SU.217	BPW-014	SU.312	BPW-011	SU.406	BPW-309	B1G19000222	BPW-178
SU.218	BPW-021	SU.313	BPW-004	SU.412	BPW-304	B1G19000232	BPW-330
SU.219	BPW-177	SU.314	BPW-018	SU.413	BPW-303	B1G19000252	BPW-203
SU.220	BPW-060	SU.315	BPW-035			B1G19000262	BPW-318
SU.220	BPW-158	SU.316	BPW-080			B1G19000422	BPW-002
SU.221	BPW-058	SU.317	BPW-032			B1G19000432	BPW-107

N.B.: I CODICI O.E. ED IL LORO TESTO SONO RIPORTATI SOLO A TITOLO INDICATIVO
THE O.E. CODES AND THEIR TEXT ARE REPORTED ONLY FOR INDICATIVE PURPOSE

GALFER	CODICE (CODE)	GIRLING	CODICE (CODE)	HELLA	CODICE (CODE)	HELLA	CODICE (CODE)
B1G19000442	BPW-319	6310302	BPW-330	8DA35505076	BPW-007	8DK35525069	BPW-014
B1G19000452	BPW-154	6310802	BPW-330	8DB35503686	BPW-007	8DK35525070	BPW-021
B1G19000472	BPW-252	6310902	BPW-178	8DD35511764	BPW-007	8DK35525071	BPW-117
B1G19000552	BPW-177	6311002	BPW-178	8DD35513183	BPW-007	8DK35525072	BPW-037
B1G19000582	BPW-325	6311202	BPW-203	8DK35525000	BPW-217	8DK35525073	BPW-028
B1G19000652	BPW-158	6315702	BPW-318	8DK35525001	BPW-054	8DK35525074	BPW-141
B1G19000742	BPW-295	6317302	BPW-325	8DK35525002	BPW-330	8DK35525076	BPW-007
B1G19000752	BPW-060	6320009	BPW-154	8DK35525003	BPW-119	8DK35525077	BPW-004
B1G19000932	BPW-007	6320209	BPW-107	8DK35525006	BPW-178	8DK35525079	BPW-099
B1G19001022	BPW-323	6322804	BPW-001	8DK35525009	BPW-252	8DK35525084	BPW-060
B1G19001182	BPW-114	6323702	BPW-060	8DK35525013	BPW-301	8DK35525085	BPW-158
B1G19001202	BPW-005	6323802	BPW-158	8DK35525014	BPW-025	8DK35525086	BPW-058
B1G19001212	BPW-321	6324201	BPW-005	8DK35525015	BPW-025	8DK35525087	BPW-039
B1G19001262	BPW-001	6324409	BPW-320	8DK35525016	BPW-203	8DK35525089	BPW-128
B1G19001332	BPW-320	6324509	BPW-319	8DK35525017	BPW-126	8DK35525093	BPW-077
B1G19001382	BPW-092	6325304	BPW-007	8DK35525018	BPW-292	8DK35525094	BPW-295
B1G19001552	BPW-169	6325909	BPW-321	8DK35525020	BPW-191	8DK35525096	BPW-018
B1G19001792	BPW-138	6326501	BPW-134	8DK35525021	BPW-307	8DK35525114	BPW-332
G1900007	BPW-003	6330802	BPW-324	8DK35525022	BPW-175	8DK35525114	BPW-333
G1900017	BPW-217	6331002	BPW-327	8DK35525025	BPW-180	8DK35525116	BPW-332
G1900042	BPW-002	6331102	BPW-329	8DK35525026	BPW-293	8DK35525116	BPW-332
G1900047	BPW-252	6331702	BPW-265	8DK35525027	BPW-085	8DK35525117	BPW-333
G1900055	BPW-177	6333301	BPW-331	8DK35525028	BPW-111	8DK35525117	BPW-333
G1900138	BPW-092	6334702	BPW-322	8DK35525029	BPW-318	8DK35525118	BPW-329
G1900179	BPW-138	6334802	BPW-323	8DK35525029	BPW-126	8DK35525119	BPW-324
		6335802	BPW-322	8DK35525030	BPW-012	8DK35525120	BPW-265
		6336402	BPW-185	8DK35525033	BPW-164	8DK35525128	BPW-193
		6336501	BPW-149	8DK35525034	BPW-177	8DK35525129	BPW-321
		6337202	BPW-305	8DK35525036	BPW-039	8DK35525129	BPW-021
				8DK35525037	BPW-040	8DK35525131	BPW-132
				8DK35525038	BPW-003	8DK35525132	BPW-204
				8DK35525039	BPW-206	8DK35525133	BPW-047
				8DK35525041	BPW-319	8DK35525136	BPW-109
				8DK35525042	BPW-325	8DK35525140	BPW-001
				8DK35525043	BPW-248	8DK35525141	BPW-327
				8DK35525044	BPW-078	8DK35525147	BPW-061
				8DK35525045	BPW-071	8DK35525148	BPW-285
				8DK35525046	BPW-131	8DK35525150	BPW-290
				8DK35525048	BPW-154	8DK35525151	BPW-320
				8DK35525050	BPW-040	8DK35525152	BPW-043
				8DK35525051	BPW-226	8DK35525162	BPW-014
				8DK35525052	BPW-112	8DK35525163	BPW-013
				8DK35525053	BPW-113	8DK35525164	BPW-082
				8DK35525054	BPW-002	8DK35525166	BPW-232
				8DK35525055	BPW-184	8DK35525167	BPW-205
				8DK35525056	BPW-317	8DK35525168	BPW-144
				8DK35525058	BPW-246	8DK35525169	BPW-331
				8DK35525059	BPW-227	8DK35525171	BPW-108
				8DK35525060	BPW-107	8DK35525172	BPW-016
				8DK35525062	BPW-096	8DK35525173	BPW-134
				8DK35525063	BPW-090	8DK35525174	BPW-029
				8DK35525064	BPW-043	8DK35525175	BPW-044
				8DK35525065	BPW-055	8DK35525176	BPW-076
				8DK35525066	BPW-081	8DK35525177	BPW-088
				8DK35525067	BPW-084	8DK35525178	BPW-063

N.B.: I CODICI O.E. ED IL LORO TESTO SONO RIPORTATI SOLO A TITOLO INDICATIVO
THE O.E. CODES AND THEIR TEXT ARE REPORTED ONLY FOR INDICATIVE PURPOSE

HELLA	CODICE (CODE)	HELLA	CODICE (CODE)	ICER	CODICE (CODE)	ICER	CODICE (CODE)
8DK35525179	BPW-079	8DZ35520193	BPW-007	610056EC	BPW-025	610500EC	BPW-096
8DK35525180	BPW-056			610057EC	BPW-054	610501EC	BPW-090
8DK35525181	BPW-181			610069EC	BPW-302	610502EC	BPW-113
8DK35525182	BPW-062			610090EC	BPW-330	610503EC	BPW-112
8DK35525183	BPW-038			610238EC	BPW-330	610504EC	BPW-141
8DK35525185	BPW-068			610239EC	BPW-178	610507EC	BPW-051
8DK35525186	BPW-065			610240EC	BPW-126	610508EC	BPW-300
8DK35525187	BPW-067			610240EC	BPW-203	610535EC	BPW-246
8DK35525188	BPW-059			610241EC	BPW-292	610536EC	BPW-132
8DK35525192	BPW-042			610242EC	BPW-126	610538EC	BPW-045
8DK35525193	BPW-027			610255EC	BPW-294	610540EC	BPW-068
8DK35525194	BPW-036			610256EC	BPW-288	610541EC	BPW-065
8DK35525196	BPW-045			610259EC	BPW-012	610542EC	BPW-063
8DK35525198	BPW-025			610299EC	BPW-325	610544EC	BPW-098
8DK35525199	BPW-025			610323EC	BPW-003	610545EC	BPW-149
8DK35525200	BPW-003			610323EC	BPW-005	610546EC	BPW-321
8DK35525201	BPW-154			610370EC	BPW-001	610547EC	BPW-027
8DK35525204	BPW-030			610377EC	BPW-061	610548EC	BPW-019
8DK35525206	BPW-198			610388EC	BPW-111	610550EC	BPW-143
8DK35525211	BPW-305			610390EC	BPW-039	610552EC	BPW-158
8DK35525214	BPW-005			610391EC	BPW-040	610553EC	BPW-060
8DK35525218	BPW-149			610394EC	BPW-178	610555EC	BPW-134
8DK35525219	BPW-051			610398EC	BPW-154	610556EC	BPW-029
8DK35525220	BPW-051			610425EC	BPW-126	610557EC	BPW-016
8DK35525221	BPW-320			610426EC	BPW-126	610558EC	BPW-013
8DK35525222	BPW-179			610426EC	BPW-318	610559EC	BPW-030
8DK35525226	BPW-289			610444EC	BPW-162	610560EC	BPW-010
8DK35525230	BPW-098			610445EC	BPW-292	610561EC	BPW-008
8DK35525231	BPW-019			610446EC	BPW-175	610565EC	BPW-323
8DK35525233	BPW-114			610447EC	BPW-180	610571EC	BPW-032
8DK35525234	BPW-008			610448EC	BPW-248	610576EC	BPW-287
8DK35525235	BPW-010			610451EC	BPW-293	610592EC	BPW-315
8DK35525236	BPW-322			610452EC	BPW-226	610603EC	BPW-081
8DK35525237	BPW-323			610454EC	BPW-107	610605EC	BPW-077
8DK35525238	BPW-149			610456EC	BPW-306	610606EC	BPW-079
8DK35525239	BPW-080			610457EC	BPW-206	610607EC	BPW-056
8DK35525240	BPW-032			610458EC	BPW-085	610612EC	BPW-295
8DK35525241	BPW-300			610468EC	BPW-286	610616EC	BPW-099
8DK35525247	BPW-185			610469EC	BPW-285	610619EC	BPW-305
8DK35525255	BPW-092			610471EC	BPW-289	610621EC	BPW-038
8DK35525258	BPW-315			610474EC	BPW-037	610623EC	BPW-134
8DK35525264	BPW-015			610475EC	BPW-028		
8DK35525267	BPW-317			610476EC	BPW-014		
8DK35525269	BPW-070			610477EC	BPW-021		
8DK35525270	BPW-050			610478EC	BPW-043		
8DK35525274	BPW-178			610479EC	BPW-055		
8DK35525281	BPW-026			610480EC	BPW-117		
8DK35525283	BPW-022			610482EC	BPW-047		
8DK35525285	BPW-053			610483EC	BPW-004		
8DK35525286	BPW-049			610484EC	BPW-018		
8DK35525289	BPW-310			610496EC	BPW-296		
8DK35525291	BPW-083			610497EC	BPW-039		
8DK35525297	BPW-169			610497EC	BPW-131		
8DK35525305	BPW-129			610498EC	BPW-071		
8DK35525306	BPW-127			610499EC	BPW-078		

N.B.: I CODICI O.E. ED IL LORO TESTO SONO RIPORTATI SOLO A TITOLO INDICATIVO
THE O.E. CODES AND THEIR TEXT ARE REPORTED ONLY FOR INDICATIVE PURPOSE

JURID	CODICE (CODE)	LPR	CODICE (CODE)	LPR	CODICE (CODE)	LPR	CODICE (CODE)
581302	BPW-330	KS0002	BPW-021	KS0080	BPW-162	KS0193	BPW-068
581358	BPW-325	KS0003	BPW-321	KS0081	BPW-141	KS0194	BPW-065
581360	BPW-319	KS0004	BPW-014	KS0082	BPW-292	KS0195	BPW-029
581374	BPW-318	KS0005	BPW-184	KS0083	BPW-252	KS0196	BPW-114
581450	BPW-321	KS0006	BPW-028	KS0086	BPW-302	KS0198	BPW-205
581486	BPW-331	KS0007	BPW-037	KS0088	BPW-175	KS0201	BPW-132
581495	BPW-322	KS0010	BPW-040	KS0089	BPW-301	KS0202	BPW-204
581503	BPW-324	KS0012	BPW-131	KS0091	BPW-307	KS0206	BPW-080
581504	BPW-327	KS0013	BPW-128	KS0096	BPW-226	KS0207	BPW-032
581505	BPW-329	KS0014	BPW-045	KS0098	BPW-180	KS0209	BPW-305
581509	BPW-329	KS0015	BPW-126	KS0099	BPW-293	KS0211	BPW-179
581300J	BPW-119	KS0018	BPW-126	KS0100	BPW-301	KS0213	BPW-329
581301J	BPW-217	KS0018	BPW-318	KS0103	BPW-324	KS0220	BPW-193
581302J	BPW-330	KS0019	BPW-217	KS0105	BPW-177	KS0229	BPW-322
581303J	BPW-178	KS0020	BPW-126	KS0122	BPW-327	KS0230	BPW-323
581306D	BPW-025	KS0020	BPW-203	KS0124	BPW-317	KS0233	BPW-149
581306J	BPW-025	KS0021	BPW-040	KS0127	BPW-288	KS0234	BPW-185
581329J	BPW-178	KS0022	BPW-039	KS0130	BPW-331	KS0236	BPW-300
581330J	BPW-203	KS0023	BPW-330	KS0136	BPW-025	KS0238	BPW-011
581337J	BPW-252	KS0024	BPW-043	KS0137	BPW-025	KS0240	BPW-315
581349J	BPW-164	KS0025	BPW-117	KS0139	BPW-295	KS0241	BPW-005
581361J	BPW-107	KS0027	BPW-206	KS0141	BPW-324	KS0242	BPW-034
581362J	BPW-177	KS0028	BPW-055	KS0144	BPW-036	KS0249	BPW-035
581366J	BPW-191	KS0029	BPW-178	KS0145	BPW-289	KS0265	BPW-022
581368J	BPW-154	KS0030	BPW-085	KS0147	BPW-294	KS0266	BPW-026
581379J	BPW-003	KS0031	BPW-111	KS0148	BPW-319	KS0268	BPW-015
581383J	BPW-002	KS0038	BPW-113	KS0149	BPW-290	KS0271	BPW-049
581385J	BPW-141	KS0039	BPW-112	KS0151	BPW-296	KS0284	BPW-087
581402J	BPW-060	KS0043	BPW-084	KS0153	BPW-076	KS0285	BPW-057
581404J	BPW-001	KS0044	BPW-081	KS0154	BPW-088		
581415J	BPW-158	KS0046	BPW-078	KS0155	BPW-062		
581417J	BPW-044	KS0047	BPW-071	KS0156	BPW-063		
581441J	BPW-295	KS0048	BPW-058	KS0157	BPW-056		
581451J	BPW-038	KS0049	BPW-060	KS0158	BPW-134		
581452J	BPW-134	KS0050	BPW-158	KS0160	BPW-016		
581462J	BPW-051	KS0051	BPW-227	KS0161	BPW-082		
581463J	BPW-149	KS0057	BPW-047	KS0162	BPW-013		
581481J	BPW-181	KS0059	BPW-186	KS0164	BPW-044		
581483J	BPW-082	KS0060	BPW-025	KS0165	BPW-108		
581501J	BPW-185	KS0061	BPW-054	KS0167	BPW-198		
581508J	BPW-265	KS0062	BPW-002	KS0168	BPW-067		
581511J	BPW-005	KS0063	BPW-295	KS0169	BPW-059		
587002D	BPW-294	KS0065	BPW-002	KS0171	BPW-099		
587002J	BPW-294	KS0067	BPW-001	KS0172	BPW-143		
587010D	BPW-012	KS0068	BPW-154	KS0173	BPW-006		
587010J	BPW-012	KS0069	BPW-107	KS0176	BPW-030		
587024D	BPW-288	KS0070	BPW-007	KS0177	BPW-008		
587024J	BPW-288	KS0071	BPW-012	KS0178	BPW-010		
587025D	BPW-294	KS0072	BPW-004	KS0179	BPW-319		
587025J	BPW-294	KS0074	BPW-248	KS0183	BPW-018		
587047J	BPW-004	KS0075	BPW-325	KS0184	BPW-312		
587048J	BPW-018	KS0076	BPW-096	KS0188	BPW-027		
		KS0077	BPW-090	KS0190	BPW-038		
		KS0078	BPW-086	KS0191	BPW-079		
		KS0079	BPW-077	KS0192	BPW-144		

N.B.: I CODICI O.E. ED IL LORO TESTO SONO RIPORTATI SOLO A TITOLO INDICATIVO
THE O.E. CODES AND THEIR TEXT ARE REPORTED ONLY FOR INDICATIVE PURPOSE

METELLI	CODICE (CODE)	METELLI	CODICE (CODE)	METELLI	CODICE (CODE)	METELLI	CODICE (CODE)
SU.011	BPW-025	SU.221	BPW-058	SU.313	BPW-004	SU.412	BPW-304
SU.012	BPW-054	SU.221	BPW-134	SU.314	BPW-018	SU.413	BPW-303
SU.072	BPW-217	SU.222	BPW-086	SU.315	BPW-035		
SU.082	BPW-252	SU.223	BPW-077	SU.316	BPW-080		
SU.083	BPW-126	SU.224	BPW-006	SU.317	BPW-032		
SU.083	BPW-203	SU.225K	BPW-285	SU.318	BPW-162		
SU.088	BPW-306	SU.226K	BPW-289	SU.319	BPW-246		
SU.090	BPW-301	SU.227K	BPW-290	SU.320	BPW-141		
SU.091	BPW-302	SU.229	BPW-047	SU.321	BPW-179		
SU.092	BPW-111	SU.242	BPW-296	SU.322	BPW-305		
SU.093	BPW-293	SU.246	BPW-184	SU.324	BPW-067		
SU.099	BPW-012	SU.247	BPW-317	SU.325	BPW-059		
SU.100K	BPW-288	SU.253	BPW-143	SU.329	BPW-287		
SU.101K	BPW-294	SU.255	BPW-099	SU.330	BPW-019		
SU.104	BPW-085	SU.256	BPW-186	SU.331	BPW-092		
SU.108	BPW-292	SU.259	BPW-128	SU.332	BPW-101		
SU.112	BPW-039	SU.260K	BPW-311	SU.338	BPW-015		
SU.113	BPW-040	SU.264	BPW-265	SU.340	BPW-297		
SU.123	BPW-248	SU.264	BPW-324	SU.341	BPW-291		
SU.129	BPW-002	SU.265	BPW-164	SU.345	BPW-083		
SU.129	BPW-005	SU.266	BPW-327	SU.346	BPW-313		
SU.129	BPW-003	SU.267	BPW-333	SU.347	BPW-031		
SU.142	BPW-180	SU.271	BPW-036	SU.348	BPW-041		
SU.143	BPW-307	SU.274	BPW-027	SU.349	BPW-310		
SU.144	BPW-175	SU.275	BPW-108	SU.350	BPW-022		
SU.145	BPW-226	SU.276	BPW-082	SU.351	BPW-026		
SU.147	BPW-131	SU.278	BPW-008	SU.352	BPW-070		
SU.148	BPW-206	SU.279	BPW-010	SU.353	BPW-050		
SU.149	BPW-096	SU.280	BPW-029	SU.357	BPW-130		
SU.150	BPW-043	SU.281	BPW-065	SU.361	BPW-049		
SU.151	BPW-112	SU.282	BPW-068	SU.362	BPW-053		
SU.152	BPW-078	SU.284	BPW-013	SU.364	BPW-127		
SU.153	BPW-132	SU.287	BPW-016	SU.365	BPW-129		
SU.155	BPW-071	SU.288	BPW-030	SU.366	BPW-124		
SU.156	BPW-204	SU.289	BPW-312	SU.368	BPW-114		
SU.157	BPW-055	SU.290	BPW-051	SU.372	BPW-299		
SU.158	BPW-113	SU.291	BPW-300	SU.373	BPW-074		
SU.161	BPW-107	SU.294	BPW-193	SU.374	BPW-057		
SU.161	BPW-154	SU.295	BPW-098	SU.376	BPW-138		
SU.162	BPW-319	SU.296	BPW-227	SU.377	BPW-102		
SU.164	BPW-001	SU.297	BPW-205	SU.379	BPW-298		
SU.164	BPW-007	SU.298	BPW-079	SU.380	BPW-314		
SU.189	BPW-090	SU.299	BPW-062	SU.383	BPW-091		
SU.195	BPW-081	SU.300	BPW-144	SU.384	BPW-139		
SU.196	BPW-084	SU.301	BPW-056	SU.385	BPW-100		
SU.204K	BPW-286	SU.302	BPW-088	SU.387	BPW-135		
SU.205	BPW-037	SU.303	BPW-063	SU.388	BPW-087		
SU.206	BPW-028	SU.304	BPW-076	SU.389	BPW-106		
SU.207	BPW-117	SU.305	BPW-045	SU.390	BPW-105		
SU.209	BPW-061	SU.307	BPW-198	SU.391	BPW-165		
SU.217	BPW-014	SU.308	BPW-181	SU.392	BPW-073		
SU.218	BPW-021	SU.309	BPW-038	SU.396	BPW-308		
SU.219	BPW-177	SU.310	BPW-044	SU.398	BPW-295		
SU.220	BPW-060	SU.311	BPW-034	SU.400	BPW-095		
SU.220	BPW-158	SU.312	BPW-011	SU.406	BPW-309		

N.B.: I CODICI O.E. ED IL LORO TESTO SONO RIPORTATI SOLO A TITOLO INDICATIVO
THE O.E. CODES AND THEIR TEXT ARE REPORTED ONLY FOR INDICATIVE PURPOSE

MINTEX	CODICE (CODE)	MINTEX	CODICE (CODE)	MINTEX	CODICE (CODE)	NK	CODICE (CODE)
MWI0102	BPW-330	MWI0229	BPW-007	MWI0492	BPW-067	280005	BPW-330
MWI0103	BPW-217	MWI0230	BPW-184	MWI0493	BPW-059	280006	BPW-119
MWI0104	BPW-119	MWI0242	BPW-295	MWI0497	BPW-042	280008	BPW-178
MWI0105	BPW-126	MWI0243	BPW-317	MWI0498	BPW-027	280009	BPW-217
MWI0106	BPW-126	MWI0244	BPW-081	MWI0499	BPW-036	280024	BPW-252
MWI0106	BPW-203	MWI0246	BPW-084	MWI0501	BPW-246	280027	BPW-203
MWI0107	BPW-178	MWI0247	BPW-028	MWI0502	BPW-045	280028	BPW-330
MWI0110	BPW-306	MWI0248	BPW-227	MWI0504	BPW-030	280037	BPW-178
MWI0111	BPW-054	MWI0249	BPW-117	MWI0506	BPW-054	280054	BPW-320
MWI0115	BPW-025	MWI0250	BPW-037	MWI0506	BPW-320	280073	BPW-318
MWI0119	BPW-292	MWI0251	BPW-061	MWI0507	BPW-198	280084	BPW-003
MWI0121	BPW-302	MWI0253	BPW-132	MWI0509	BPW-300	280086	BPW-325
MWI0123	BPW-301	MWI0254	BPW-204	MWI0514	BPW-114	280097	BPW-154
MWI0124	BPW-252	MWI0259	BPW-128	MWI0516	BPW-008	280098	BPW-319
MWI0125	BPW-302	MWI0263	BPW-109	MWI0517	BPW-010	280100	BPW-107
MWI0126	BPW-175	MWI0265	BPW-099	MWI0519	BPW-322	280101	BPW-002
MWI0129	BPW-301	MWI0266	BPW-018	MWI0520	BPW-323	280113	BPW-321
MWI0154	BPW-191	MWI0403	BPW-060	MWI0523	BPW-080	280114	BPW-004
MWI0157	BPW-175	MWI0404	BPW-158	MWI0524	BPW-032	280114	BPW-007
MWI0158	BPW-307	MWI0407	BPW-043	MWI0525	BPW-305	280116	BPW-007
MWI0161	BPW-318	MWI0416	BPW-186	MWI0528	BPW-005	280117	BPW-184
MWI0163	BPW-085	MWI0440	BPW-332	MWI0529	BPW-149	280128	BPW-295
MWI0164	BPW-111	MWI0440	BPW-333	MWI0531	BPW-051	280129	BPW-317
MWI0165	BPW-180	MWI0442	BPW-332	MWI0533	BPW-179	280138	BPW-018
MWI0166	BPW-293	MWI0443	BPW-333	MWI0534	BPW-149	280150	BPW-003
MWI0168	BPW-012	MWI0444	BPW-329	MWI0540	BPW-206	280153	BPW-227
MWI0171	BPW-025	MWI0445	BPW-324	MWI0542	BPW-098	280165	BPW-047
MWI0172	BPW-025	MWI0446	BPW-265	MWI0543	BPW-019	280172	BPW-060
MWI0173	BPW-025	MWI0450	BPW-193	MWI0545	BPW-295	280176	BPW-193
MWI0179	BPW-288	MWI0451	BPW-321	MWI0547	BPW-164	280182	BPW-134
MWI0184	BPW-320	MWI0453	BPW-001	MWI0551	BPW-185	280183	BPW-038
MWI0191	BPW-039	MWI0454	BPW-327	MWI0554	BPW-035	280184	BPW-082
MWI0192	BPW-040	MWI0456	BPW-285	MWI0555	BPW-101	280187	BPW-108
MWI0196	BPW-003	MWI0458	BPW-290	MWI0559	BPW-092	280188	BPW-013
MWI0197	BPW-248	MWI0466	BPW-289	MWI0562	BPW-315	280192	BPW-079
MWI0198	BPW-325	MWI0467	BPW-014	MWI0568	BPW-015	280193	BPW-198
MWI0199	BPW-131	MWI0468	BPW-013	MWI0571	BPW-317	280195	BPW-144
MWI0200	BPW-071	MWI0469	BPW-082	MWI0574	BPW-070	280196	BPW-181
MWI0201	BPW-078	MWI0472	BPW-205	MWI0575	BPW-050	280197	BPW-044
MWI0207	BPW-154	MWI0473	BPW-144	MWI0577	BPW-137	280198	BPW-067
MWI0209	BPW-154	MWI0474	BPW-331	MWI0578	BPW-178	280199	BPW-059
MWI0210	BPW-319	MWI0476	BPW-108	MWI0592	BPW-053	280202	BPW-029
MWI0212	BPW-107	MWI0477	BPW-016	MWI0593	BPW-049	280203	BPW-030
MWI0213	BPW-002	MWI0478	BPW-134	MWI0604	BPW-169	280204	BPW-016
MWI0214	BPW-002	MWI0479	BPW-029	MWI0612	BPW-129	280205	BPW-114
MWI0216	BPW-096	MWI0480	BPW-044	MWI0613	BPW-127	280207	BPW-065
MWI0217	BPW-090	MWI0481	BPW-076	MWI0628	BPW-073	280208	BPW-036
MWI0218	BPW-043	MWI0482	BPW-088			280209	BPW-027
MWI0219	BPW-055	MWI0483	BPW-063			280212	BPW-088
MWI0220	BPW-226	MWI0484	BPW-079			280213	BPW-008
MWI0222	BPW-113	MWI0486	BPW-181			280214	BPW-010
MWI0224	BPW-112	MWI0487	BPW-062			280217	BPW-076
MWI0225	BPW-014	MWI0488	BPW-038			280221	BPW-315
MWI0226	BPW-021	MWI0490	BPW-068			280223	BPW-080
MWI0227	BPW-004	MWI0491	BPW-065			280231	BPW-015

N.B.: I CODICI O.E. ED IL LORO TESTO SONO RIPORTATI SOLO A TITOLO INDICATIVO
THE O.E. CODES AND THEIR TEXT ARE REPORTED ONLY FOR INDICATIVE PURPOSE

NK	CODICE (CODE)	OPENPARTS	CODICE (CODE)	OPENPARTS	CODICE (CODE)	OPTIMAL	CODICE (CODE)
280244	BPW-070	AK3004.00	BPW-126	AK3153.00	BPW-026	WKT50004K	BPW-330
280245	BPW-073	AK3010.00	BPW-054	AK3155.00	BPW-044	WKT50040K	BPW-178
280260	BPW-124	AK3015.00	BPW-292	AK3173.00	BPW-114	WKT50165K	BPW-178
280261	BPW-049	AK3053.00	BPW-175	AK3183.00	BPW-015	WKT50180K	BPW-203
280262	BPW-053	AK3054.00	BPW-307	AK3201.00	BPW-169	WKT50206K	BPW-178
280264	BPW-100	AK3057.00	BPW-085			WKT50211K	BPW-330
280265	BPW-139	AK3058.00	BPW-111			WKT50283K	BPW-318
280266	BPW-091	AK3059.00	BPW-180			WKT50337K	BPW-319
280276	BPW-179	AK3060.00	BPW-293			WKT50349K	BPW-320
284701	BPW-185	AK3061.00	BPW-012			WKT50392K	BPW-325
284703	BPW-149	AK3064.00	BPW-025			WKT50445K	BPW-154
284707	BPW-323	AK3074.00	BPW-039			WKT50504K	BPW-107
284708	BPW-322	AK3075.00	BPW-040			WKT50545K	BPW-321
284710	BPW-321	AK3077.00	BPW-162			WKT50581K	BPW-007
890005	BPW-330	AK3079.00	BPW-248			WKT50607K	BPW-001
890008	BPW-178	AK3081.00	BPW-071			WKT50642K	BPW-060
890027	BPW-203	AK3082.00	BPW-078			WKT50645K	BPW-158
890028	BPW-330	AK3085.00	BPW-131			WKT60001K	BPW-321
890037	BPW-178	AK3086.00	BPW-206			WKT60001K	BPW-323
890054	BPW-320	AK3090.00	BPW-288			WKT60015K	BPW-324
		AK3095.00	BPW-096			WKT60027K	BPW-134
		AK3096.00	BPW-043			WKT60040K	BPW-327
		AK3098.00	BPW-226			WKT60074K	BPW-329
		AK3099.00	BPW-113			WKT60076K	BPW-331
		AK3100.00	BPW-112			WKT60085K	BPW-185
		AK3101.00	BPW-014			WKT60089K	BPW-134
		AK3102.00	BPW-021			WKT60092K	BPW-315
		AK3104.00	BPW-184			WKT60093K	BPW-005
		AK3107.00	BPW-090				
		AK3109.00	BPW-081				
		AK3110.00	BPW-084				
		AK3111.00	BPW-028				
		AK3113.00	BPW-117				
		AK3114.00	BPW-037				
		AK3117.00	BPW-132				
		AK3118.00	BPW-204				
		AK3119.00	BPW-141				
		AK3121.00	BPW-004				
		AK3122.00	BPW-128				
		AK3123.00	BPW-006				
		AK3123.00	BPW-083				
		AK3125.00	BPW-058				
		AK3127.00	BPW-047				
		AK3128.00	BPW-099				
		AK3130.00	BPW-086				
		AK3131.00	BPW-077				
		AK3133.00	BPW-285				
		AK3134.00	BPW-286				
		AK3135.00	BPW-018				
		AK3139.00	BPW-132				
		AK3145.00	BPW-067				
		AK3146.00	BPW-059				
		AK3147.00	BPW-027				
		AK3150.00	BPW-068				
		AK3151.00	BPW-065				

N.B.: I CODICI O.E. ED IL LORO TESTO SONO RIPORTATI SOLO A TITOLO INDICATIVO
THE O.E. CODES AND THEIR TEXT ARE REPORTED ONLY FOR INDICATIVE PURPOSE

QUINTON	CODICE (CODE)	REMSA	CODICE (CODE)	REMSA	CODICE (CODE)	TEXTAR	CODICE (CODE)
BP5001	BPW-119	001001	BPW-054	001076	BPW-004	98008100	BPW-330
BP5002	BPW-217	001002	BPW-025	001077	BPW-006	98008110	BPW-330
BP5004	BPW-178	001003	BPW-330	001079	BPW-060	98008200	BPW-119
BP5005	BPW-203	001006	BPW-302	001080	BPW-058	98008300	BPW-217
BP5015	BPW-252	001009	BPW-012	001081	BPW-128	98008900	BPW-302
BWI1020	BPW-162	001010	BPW-292	001082	BPW-296	98012600	BPW-252
BWI1066	BPW-141	001014	BPW-126	001084	BPW-047	98015700	BPW-301
BWI1071	BPW-164	001015	BPW-126	001085	BPW-099	98017800	BPW-301
BWI1083	BPW-004	001016	BPW-126	001087	BPW-086	98019100	BPW-306
BWI1090	BPW-295	001016	BPW-203	001088	BPW-077	98019900	BPW-191
BWI1096	BPW-063	001017	BPW-040	001090	BPW-265	98020000	BPW-307
BWI1100	BPW-114	001018	BPW-039	001090	BPW-324	98020800	BPW-318
BWI1203	BPW-305	001022	BPW-111	001092	BPW-288	98020810	BPW-318
BWI1205	BPW-179	001023	BPW-206	001093	BPW-285	98022600	BPW-164
BWI1241	BPW-082	001024	BPW-085	001094	BPW-286	98022700	BPW-177
BWI1257	BPW-051	001026	BPW-306	001095	BPW-018	98024700	BPW-003
BZF5001	BPW-119	001028	BPW-292	001096	BPW-001	98024701	BPW-003
BZF5002	BPW-217	001029	BPW-175	001098	BPW-158	98026200	BPW-319
BZF5017	BPW-252	001030	BPW-180	001101	BPW-088	98026210	BPW-319
BZF5028	BPW-191	001031	BPW-325	001102	BPW-062	98026500	BPW-325
		001032	BPW-248	001103	BPW-056	98027100	BPW-154
		001033	BPW-306	001104	BPW-067	98029400	BPW-002
		001036	BPW-293	001105	BPW-059	98029600	BPW-317
		001037	BPW-226	001106	BPW-027	98030000	BPW-107
		001039	BPW-003	001108	BPW-036	98033800	BPW-007
		001040	BPW-014	001109	BPW-079	98035000	BPW-060
		001041	BPW-021	001111	BPW-205	98035100	BPW-158
		001042	BPW-319	001112	BPW-144	98037200	BPW-332
		001043	BPW-007	001113	BPW-068	98037200	BPW-333
		001046	BPW-307	001114	BPW-065	98037400	BPW-332
		001047	BPW-126	001115	BPW-134	98037500	BPW-333
		001047	BPW-318	001117	BPW-016	98037800	BPW-329
		001048	BPW-071	001118	BPW-013	98037810	BPW-329
		001049	BPW-078	001119	BPW-044	98037900	BPW-324
		001050	BPW-131	001120	BPW-029	98037910	BPW-324
		001051	BPW-154	001123	BPW-005	98038000	BPW-265
		001052	BPW-040	001129	BPW-063	98038900	BPW-321
		001053	BPW-107	001147	BPW-321	98038901	BPW-321
		001054	BPW-096	001148	BPW-178	98038910	BPW-321
		001055	BPW-043	001151	BPW-164	98039700	BPW-109
		001056	BPW-055	001155	BPW-331	98040100	BPW-001
		001057	BPW-113	001156	BPW-178	98040200	BPW-327
		001058	BPW-112	001190	BPW-169	98040210	BPW-327
		001060	BPW-184	001200	BPW-138	98042500	BPW-082
		001063	BPW-090			98042700	BPW-232
		001065	BPW-081			98043000	BPW-331
		001066	BPW-084			98043010	BPW-331
		001067	BPW-028			98043400	BPW-134
		001068	BPW-227			98043900	BPW-063
		001069	BPW-117			98045300	BPW-042
		001070	BPW-037			98046100	BPW-002
		001071	BPW-061			98046500	BPW-300
		001073	BPW-132			98047800	BPW-322
		001074	BPW-204			98047801	BPW-322
		001075	BPW-141			98047900	BPW-323

N.B.: I CODICI O.E. ED IL LORO TESTO SONO RIPORTATI SOLO A TITOLO INDICATIVO
THE O.E. CODES AND THEIR TEXT ARE REPORTED ONLY FOR INDICATIVE PURPOSE

TEXTAR	CODICE (CODE)	TRUSTING	CODICE (CODE)	TRUSTING	CODICE (CODE)	TRUSTING	CODICE (CODE)
98047901	BPW-323	SU.011	BPW-025	SU.221	BPW-134	SU.318	BPW-162
98048400	BPW-305	SU.012	BPW-054	SU.222	BPW-086	SU.319	BPW-246
98048700	BPW-005	SU.072	BPW-217	SU.223	BPW-077	SU.320	BPW-141
98049201	BPW-149	SU.082	BPW-252	SU.224	BPW-006	SU.321	BPW-179
98049300	BPW-051	SU.083	BPW-126	SU.225K	BPW-285	SU.322	BPW-305
98049400	BPW-051	SU.083	BPW-203	SU.226K	BPW-289	SU.324	BPW-067
98049500	BPW-320	SU.088	BPW-306	SU.227K	BPW-290	SU.325	BPW-059
98049510	BPW-320	SU.090	BPW-301	SU.229	BPW-047	SU.329	BPW-287
98049600	BPW-179	SU.091	BPW-302	SU.242	BPW-296	SU.330	BPW-019
98051000	BPW-185	SU.092	BPW-111	SU.246	BPW-184	SU.331	BPW-092
98051600	BPW-315	SU.093	BPW-293	SU.253	BPW-143	SU.332	BPW-101
98051610	BPW-315	SU.099	BPW-012	SU.255	BPW-099	SU.338	BPW-015
98052200	BPW-137	SU.100K	BPW-288	SU.256	BPW-186	SU.340	BPW-297
98054800	BPW-092	SU.101K	BPW-294	SU.259	BPW-128	SU.341	BPW-291
98056400	BPW-178	SU.104	BPW-085	SU.260K	BPW-311	SU.345	BPW-083
98056410	BPW-178	SU.108	BPW-292	SU.264	BPW-265	SU.346	BPW-313
98056500	BPW-317	SU.112	BPW-039	SU.265	BPW-164	SU.347	BPW-031
98056510	BPW-317	SU.113	BPW-040	SU.271	BPW-036	SU.348	BPW-041
98056600	BPW-310	SU.123	BPW-248	SU.274	BPW-027	SU.349	BPW-310
98057800	BPW-073	SU.129	BPW-002	SU.275	BPW-108	SU.350	BPW-022
98058000	BPW-130	SU.129	BPW-005	SU.276	BPW-082	SU.351	BPW-026
98058300	BPW-070	SU.129	BPW-003	SU.278	BPW-008	SU.352	BPW-070
98059100	BPW-169	SU.142	BPW-180	SU.279	BPW-010	SU.353	BPW-050
98060300	BPW-308	SU.143	BPW-307	SU.280	BPW-029	SU.357	BPW-130
98068300	BPW-309	SU.144	BPW-175	SU.281	BPW-065	SU.361	BPW-049
96990008201	BPW-119	SU.145	BPW-226	SU.282	BPW-068	SU.362	BPW-053
96990008301	BPW-217	SU.147	BPW-131	SU.284	BPW-013	SU.364	BPW-127
96990012601	BPW-252	SU.148	BPW-206	SU.287	BPW-016	SU.365	BPW-129
96990015701	BPW-301	SU.149	BPW-096	SU.288	BPW-030	SU.366	BPW-124
96990017801	BPW-301	SU.150	BPW-043	SU.289	BPW-312	SU.368	BPW-114
96990019901	BPW-191	SU.151	BPW-112	SU.290	BPW-051	SU.372	BPW-299
96990022601	BPW-164	SU.152	BPW-078	SU.291	BPW-300	SU.373	BPW-074
96990022701	BPW-177	SU.153	BPW-132	SU.294	BPW-193	SU.374	BPW-057
96990024701	BPW-003	SU.155	BPW-071	SU.295	BPW-098	SU.376	BPW-138
96990029401	BPW-002	SU.156	BPW-204	SU.296	BPW-227	SU.377	BPW-102
96990039701	BPW-109	SU.157	BPW-055	SU.297	BPW-205	SU.379	BPW-298
KR1233082	BPW-301	SU.158	BPW-113	SU.298	BPW-079	SU.380	BPW-314
KR1233492	BPW-301	SU.161	BPW-107	SU.299	BPW-062	SU.383	BPW-091
		SU.161	BPW-154	SU.300	BPW-144	SU.384	BPW-139
		SU.164	BPW-001	SU.301	BPW-056	SU.385	BPW-100
		SU.164	BPW-007	SU.302	BPW-088	SU.387	BPW-135
		SU.189	BPW-090	SU.303	BPW-063	SU.388	BPW-087
		SU.195	BPW-081	SU.304	BPW-076	SU.389	BPW-106
		SU.196	BPW-084	SU.305	BPW-045	SU.390	BPW-105
		SU.204K	BPW-286	SU.307	BPW-198	SU.391	BPW-165
		SU.205	BPW-037	SU.308	BPW-181	SU.392	BPW-073
		SU.206	BPW-028	SU.309	BPW-038	SU.396	BPW-308
		SU.207	BPW-117	SU.310	BPW-044	SU.398	BPW-295
		SU.209	BPW-061	SU.311	BPW-034	SU.400	BPW-095
		SU.217	BPW-014	SU.312	BPW-011	SU.406	BPW-309
		SU.218	BPW-021	SU.313	BPW-004	SU.412	BPW-304
		SU.219	BPW-177	SU.314	BPW-018	SU.413	BPW-303
		SU.220	BPW-060	SU.315	BPW-035	X70266	BPW-029
		SU.220	BPW-158	SU.316	BPW-080	X70267	BPW-044
		SU.221	BPW-058	SU.317	BPW-032	X70268	BPW-076

N.B.: I CODICI O.E. ED IL LORO TESTO SONO RIPORTATI SOLO A TITOLO INDICATIVO
THE O.E. CODES AND THEIR TEXT ARE REPORTED ONLY FOR INDICATIVE PURPOSE

TRW	CODICE (CODE)	TRW	CODICE (CODE)	TRW	CODICE (CODE)	TRW	CODICE (CODE)
GIC101	BPW-217	GIC196	BPW-184	GIC268	BPW-076	GIC387	BPW-035
GIC102	BPW-119	GIC197	BPW-246	GIC269	BPW-088	GIC389	BPW-101
GIC103	BPW-330	GIC198	BPW-002	GIC270	BPW-063	GIC390	BPW-092
GIC104	BPW-054	GIC199	BPW-288	GIC271	BPW-079	GIC398	BPW-003
GIC108	BPW-330	GIC200	BPW-154	GIC272	BPW-056	GIC404	BPW-011
GIC109	BPW-178	GIC202	BPW-107	GIC273	BPW-181	GIC407	BPW-015
GIC110	BPW-178	GIC202	BPW-154	GIC274	BPW-062	GIC408	BPW-287
GIC111	BPW-126	GIC203	BPW-004	GIC275	BPW-038	GIC409	BPW-315
GIC112	BPW-126	GIC204	BPW-081	GIC277	BPW-030	GIC410	BPW-291
GIC112	BPW-203	GIC205	BPW-289	GIC285	BPW-068	GIC413	BPW-318
GIC117	BPW-191	GIC206	BPW-084	GIC286	BPW-065	GIC436	BPW-050
GIC122	BPW-025	GIC207	BPW-028	GIC287	BPW-067	GIC470	BPW-139
GIC125	BPW-252	GIC208	BPW-227	GIC288	BPW-059	GIC471	BPW-100
GIC126	BPW-301	GIC209	BPW-117	GIC308	BPW-324	GIC473	BPW-165
GIC126	BPW-301	GIC210	BPW-037	GIC310	BPW-327	GIC476	BPW-308
GIC127	BPW-302	GIC210	BPW-076	GIC311	BPW-329	GIC5002	BPW-294
GIC130	BPW-301	GIC213	BPW-132	GIC315	BPW-332	GIC5017	BPW-294
GIC133	BPW-292	GIC214	BPW-204	GIC316	BPW-333	GIC5021	BPW-288
GIC134	BPW-307	GIC215	BPW-141	GIC317	BPW-265		
GIC135	BPW-175	GIC215	BPW-149	GIC324	BPW-042		
GIC156	BPW-306	GIC216	BPW-128	GIC325	BPW-027		
GIC157	BPW-126	GIC218	BPW-047	GIC326	BPW-036		
GIC157	BPW-318	GIC220	BPW-109	GIC327	BPW-013		
GIC158	BPW-085	GIC221	BPW-186	GIC328	BPW-082		
GIC159	BPW-111	GIC222	BPW-099	GIC330	BPW-232		
GIC160	BPW-293	GIC223	BPW-018	GIC331	BPW-205		
GIC160	BPW-180	GIC228	BPW-001	GIC332	BPW-144		
GIC161	BPW-180	GIC229	BPW-295	GIC333	BPW-331		
GIC161	BPW-293	GIC230	BPW-317	GIC335	BPW-108		
GIC162	BPW-012	GIC236	BPW-058	GIC336	BPW-003		
GIC164	BPW-025	GIC237	BPW-060	GIC338	BPW-198		
GIC165	BPW-025	GIC238	BPW-158	GIC339	BPW-114		
GIC168	BPW-039	GIC240	BPW-045	GIC340	BPW-008		
GIC169	BPW-040	GIC242	BPW-002	GIC341	BPW-010		
GIC171	BPW-162	GIC242	BPW-005	GIC342	BPW-290		
GIC172	BPW-003	GIC243	BPW-006	GIC343	BPW-285		
GIC173	BPW-325	GIC244	BPW-054	GIC344	BPW-311		
GIC174	BPW-248	GIC244	BPW-320	GIC345	BPW-289		
GIC175	BPW-131	GIC245	BPW-319	GIC346	BPW-286		
GIC176	BPW-071	GIC247	BPW-086	GIC347	BPW-322		
GIC177	BPW-078	GIC248	BPW-077	GIC348	BPW-021		
GIC178	BPW-206	GIC250	BPW-143	GIC348	BPW-323		
GIC178	BPW-039	GIC251	BPW-186	GIC350	BPW-019		
GIC180	BPW-040	GIC253	BPW-007	GIC356	BPW-006		
GIC184	BPW-003	GIC257	BPW-021	GIC358	BPW-051		
GIC185	BPW-096	GIC258	BPW-021	GIC359	BPW-051		
GIC186	BPW-090	GIC258	BPW-193	GIC360	BPW-098		
GIC187	BPW-043	GIC259	BPW-021	GIC361	BPW-300		
GIC188	BPW-055	GIC259	BPW-321	GIC364	BPW-185		
GIC188	BPW-117	GIC262	BPW-164	GIC365	BPW-149		
GIC189	BPW-226	GIC263	BPW-177	GIC366	BPW-312		
GIC190	BPW-113	GIC264	BPW-016	GIC372	BPW-305		
GIC192	BPW-112	GIC265	BPW-134	GIC373	BPW-179		
GIC193	BPW-014	GIC266	BPW-029	GIC376	BPW-080		
GIC194	BPW-021	GIC267	BPW-044	GIC377	BPW-032		

N.B.: I CODICI O.E. ED IL LORO TESTO SONO RIPORTATI SOLO A TITOLO INDICATIVO
THE O.E. CODES AND THEIR TEXT ARE REPORTED ONLY FOR INDICATIVE PURPOSE

VALEO	CODICE (CODE)	WOKING	CODICE (CODE)	WOKING	CODICE (CODE)	X-ENERGY	CODICE (CODE)
431821	BPW-054	001001	BPW-054	001077	BPW-006	X70101	BPW-217
431822	BPW-126	001002	BPW-025	001080	BPW-058	X70104	BPW-054
431825	BPW-012	001003	BPW-330	001081	BPW-128	X70111	BPW-126
431826	BPW-025	001006	BPW-302	001082	BPW-296	X70112	BPW-203
431827	BPW-126	001009	BPW-012	001084	BPW-047	X70125	BPW-252
431828	BPW-025	001010	BPW-292	001085	BPW-099	X70133	BPW-292
431831	BPW-085	001014	BPW-126	001087	BPW-086	X70156	BPW-306
431833	BPW-039	001015	BPW-126	001088	BPW-077	X70158	BPW-085
431834	BPW-175	001016	BPW-126	001090	BPW-265	X70159	BPW-111
431835	BPW-040	001016	BPW-203	001092	BPW-288	X70160	BPW-180
431836	BPW-292	001017	BPW-040	001093	BPW-285	X70161	BPW-293
431838	BPW-111	001018	BPW-039	001094	BPW-286	X70162	BPW-012
431845	BPW-301	001022	BPW-111	001095	BPW-018	X70164	BPW-025
431847	BPW-206	001023	BPW-206	001096	BPW-001	X70168	BPW-039
431850	BPW-126	001024	BPW-085	001098	BPW-158	X70169	BPW-040
		001026	BPW-306	001101	BPW-088	X70171	BPW-162
		001028	BPW-292	001102	BPW-062	X70174	BPW-248
		001029	BPW-175	001103	BPW-056	X70175	BPW-131
		001030	BPW-180	001104	BPW-067	X70176	BPW-071
		001031	BPW-325	001105	BPW-059	X70177	BPW-078
		001032	BPW-248	001106	BPW-027	X70178	BPW-206
		001033	BPW-306	001108	BPW-036	X70185	BPW-096
		001036	BPW-293	001109	BPW-079	X70186	BPW-090
		001037	BPW-226	001111	BPW-205	X70187	BPW-043
		001040	BPW-014	001112	BPW-144	X70188	BPW-055
		001041	BPW-021	001113	BPW-068	X70188	BPW-117
		001042	BPW-319	001114	BPW-065	X70190	BPW-113
		001043	BPW-007	001115	BPW-134	X70192	BPW-112
		001046	BPW-307	001117	BPW-016	X70193	BPW-014
		001047	BPW-126	001118	BPW-013	X70194	BPW-021
		001047	BPW-318	001119	BPW-044	X70196	BPW-184
		001048	BPW-071	001120	BPW-029	X70197	BPW-246
		001049	BPW-078	001123	BPW-005	X70198	BPW-002
		001050	BPW-131	001147	BPW-321	X7020001	BPW-307
		001051	BPW-154	001148	BPW-178	X70202	BPW-107
		001052	BPW-040	001155	BPW-331	X70202	BPW-154
		001053	BPW-107	001156	BPW-178	X70203	BPW-004
		001054	BPW-096	001190	BPW-169	X70206	BPW-084
		001055	BPW-043			X70207	BPW-028
		001056	BPW-055			X70208	BPW-227
		001057	BPW-113			X70210	BPW-037
		001058	BPW-112			X70213	BPW-132
		001060	BPW-184			X70214	BPW-204
		001063	BPW-090			X70218	BPW-047
		001065	BPW-081			X70223	BPW-018
		001066	BPW-084			X70236	BPW-058
		001067	BPW-028			X70240	BPW-045
		001068	BPW-227			X70242	BPW-005
		001069	BPW-117			X70248	BPW-077
		001070	BPW-037			X7024801	BPW-288
		001071	BPW-061			X70264	BPW-016
		001073	BPW-132			X70265	BPW-134
		001074	BPW-204			X70266	BPW-029
		001075	BPW-141			X70267	BPW-044
		001076	BPW-004			X70268	BPW-076

N.B.: I CODICI O.E. ED IL LORO TESTO SONO RIPORTATI SOLO A TITOLO INDICATIVO
THE O.E. CODES AND THEIR TEXT ARE REPORTED ONLY FOR INDICATIVE PURPOSE



 **SCLERA** | Kromeda
Vehicle Repair

 **TecAlliance**
Certified Data Supplier

 **sofinn** ITALIA
Software innovativo

 **ClipParts**
CATALOGO ELETTRONICO

BRAKE PADS WEAR SENSORS SENSORI USURA FRENO



www.japko.it

JAPANPARTS S.R.L.

Via della Meccanica, 1/A - 37139 - Verona (IT)
tel. +39 045 8517711 - fax + 39 045 8510714
info@japanparts.it